

Kameleon by Artur Biernacki

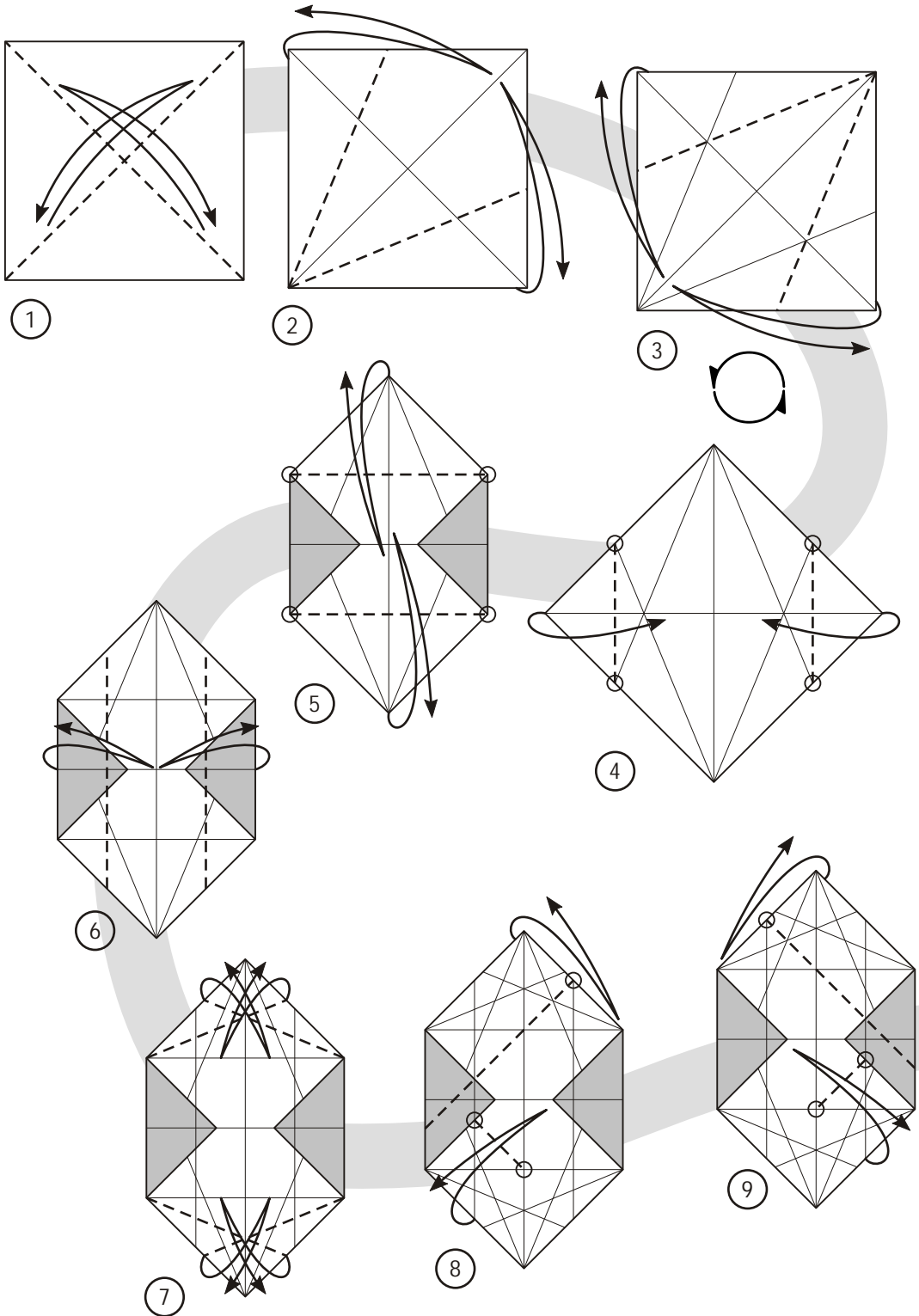

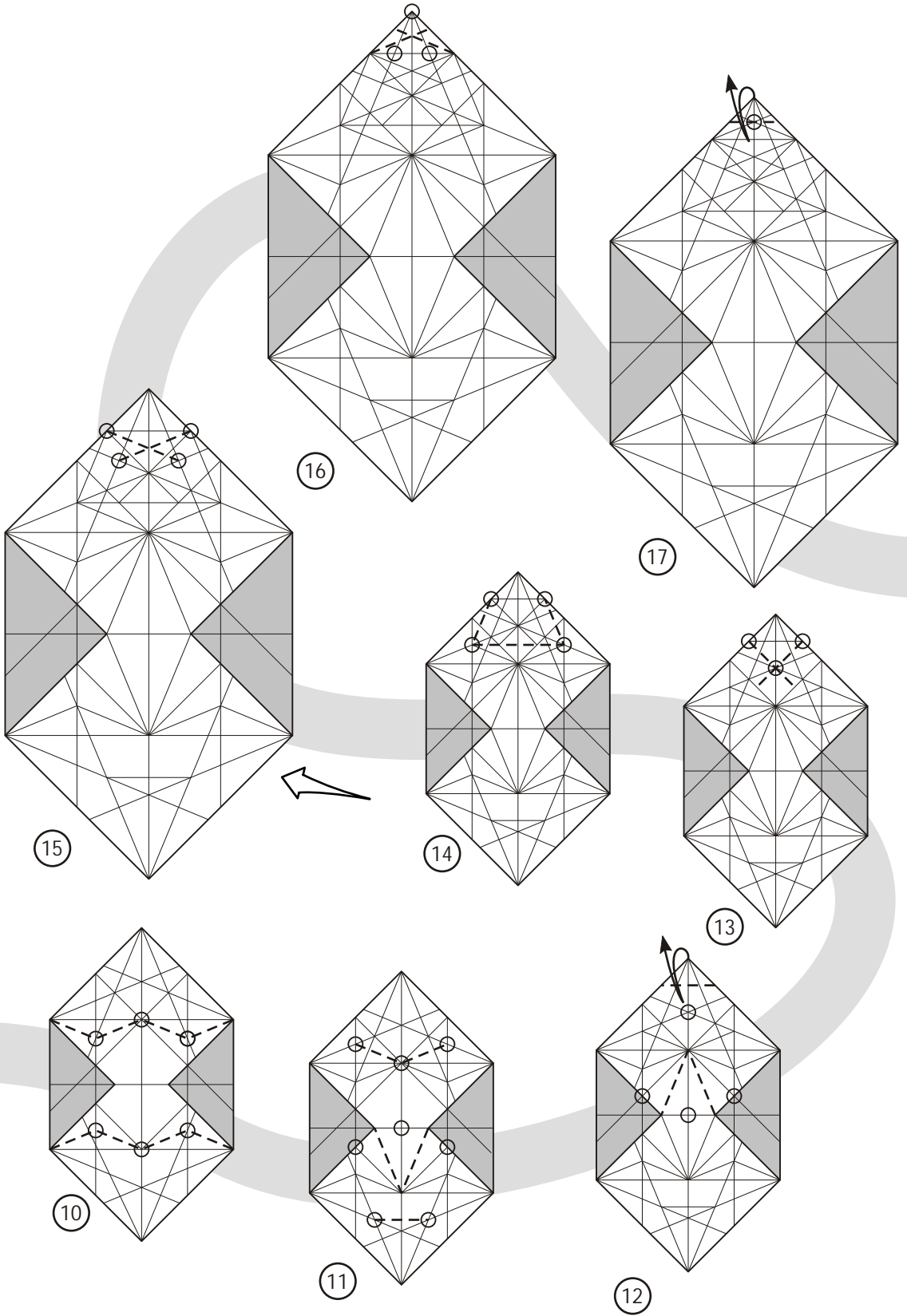

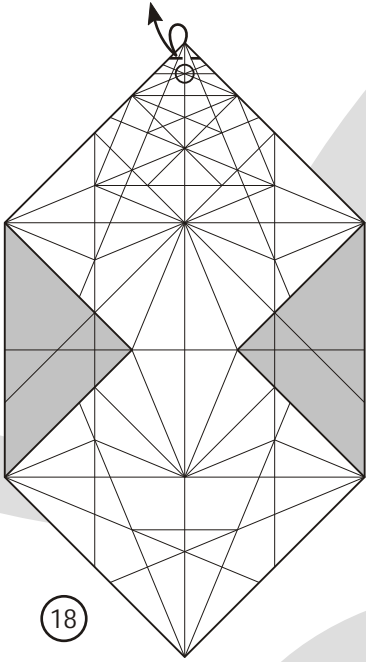

18

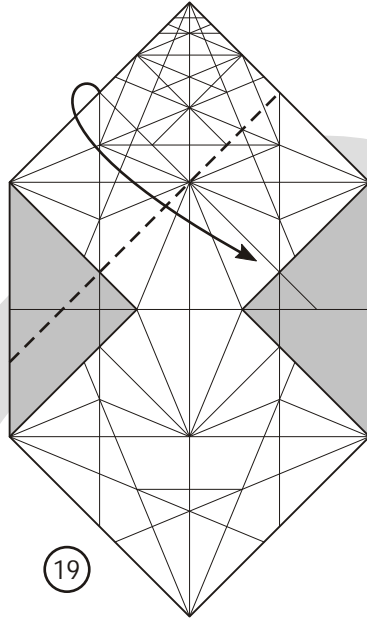

19

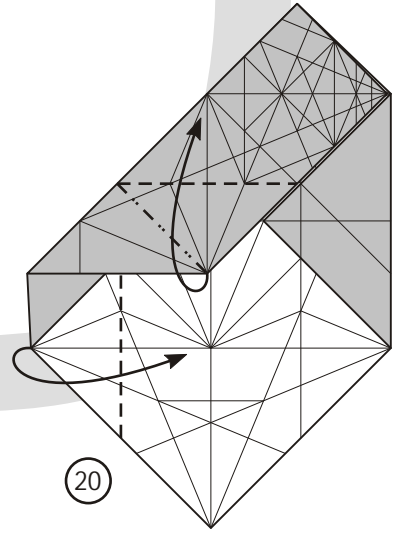

20

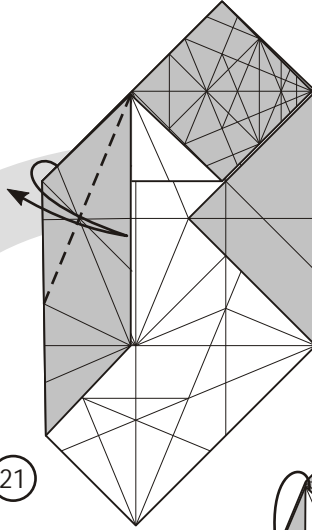

21

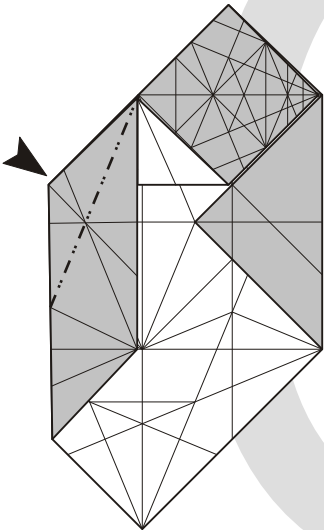

22 Open sink.

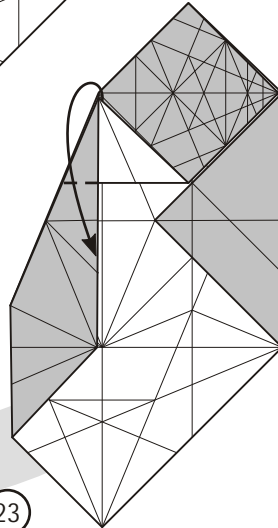

23

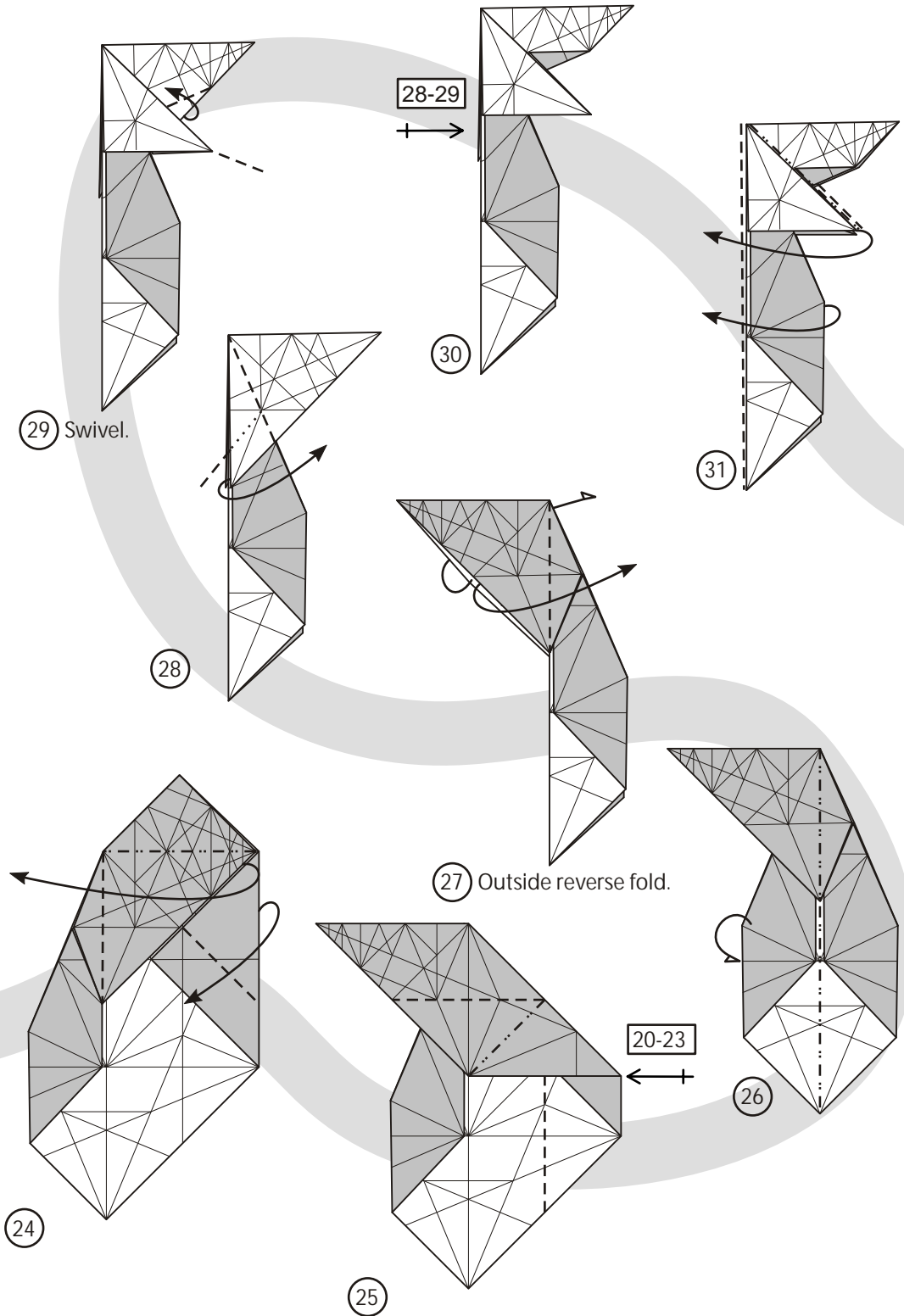

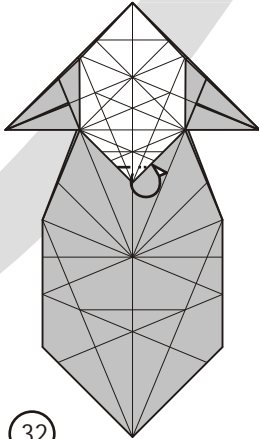

32

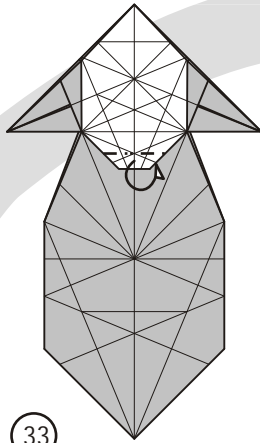

33

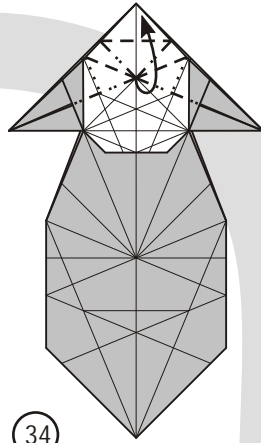

34

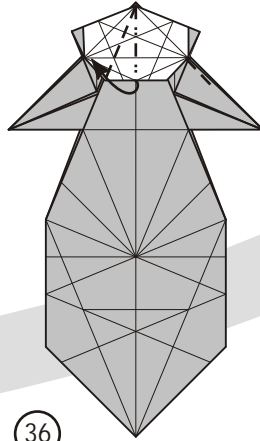

36

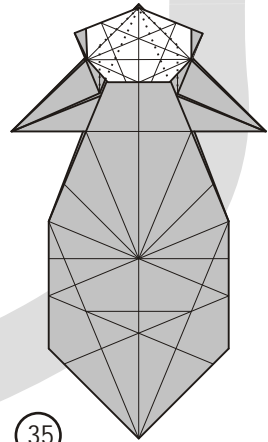

35

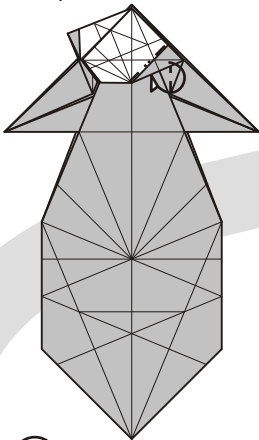

37 Swivel.

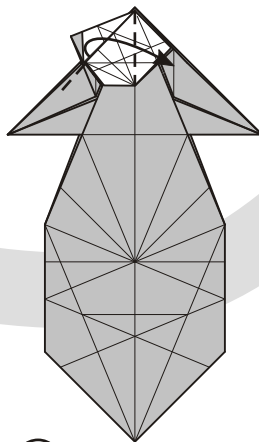

38

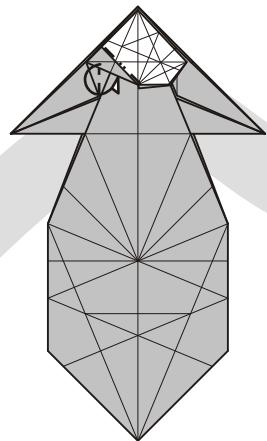

39 Swivel.

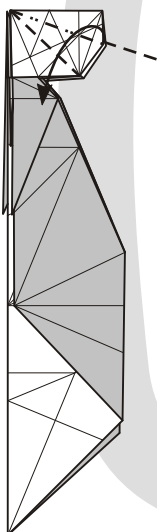
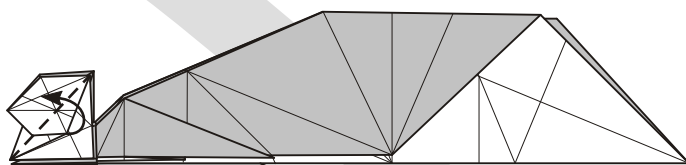
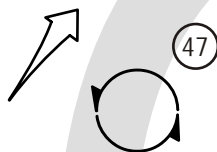
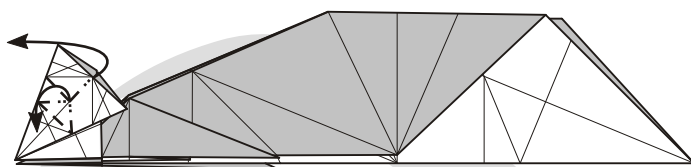

48

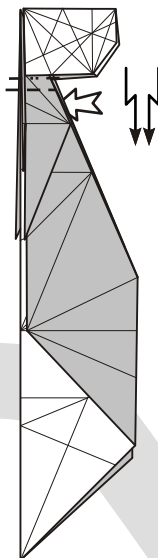
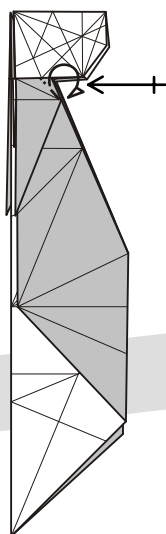

46

45

44

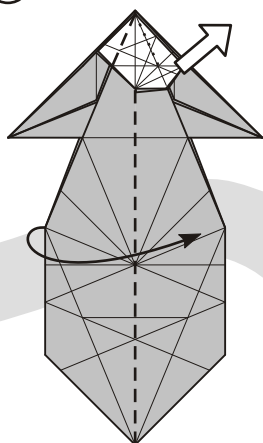

40

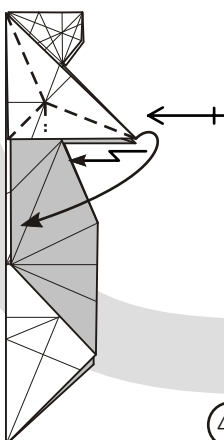

41 Rabbit ear.

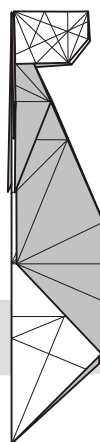

42

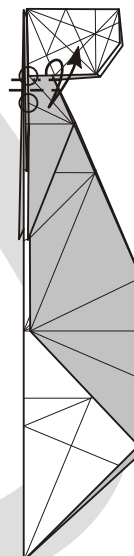

43

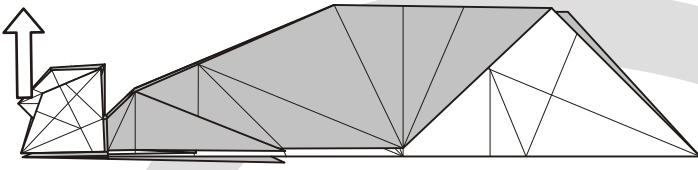

49

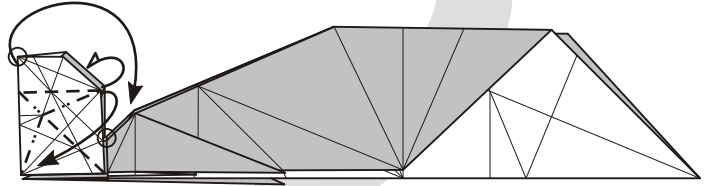

50

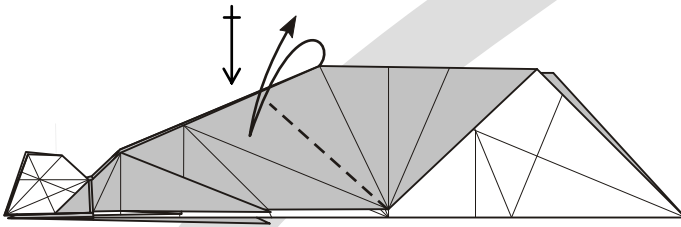

51

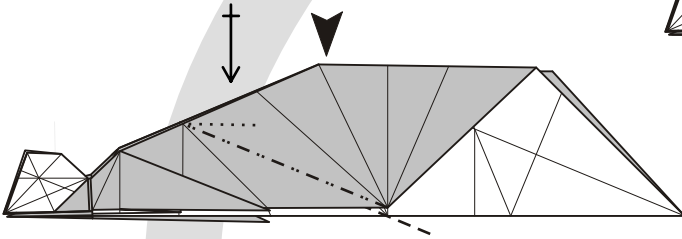

52

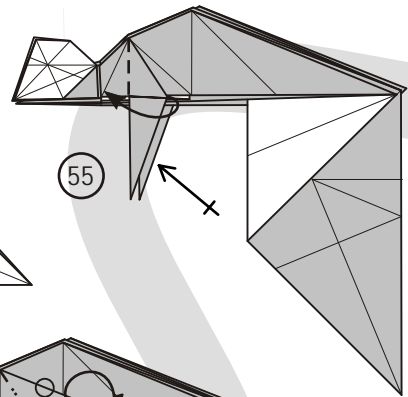

55

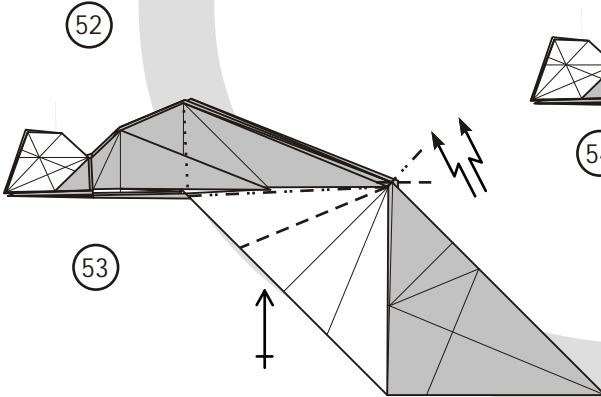

53

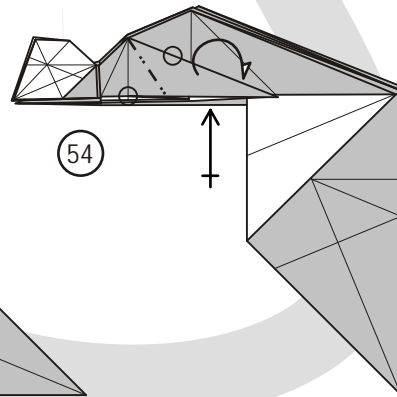

54

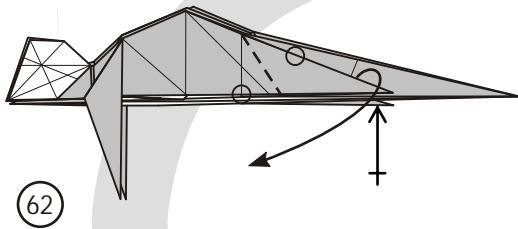

62

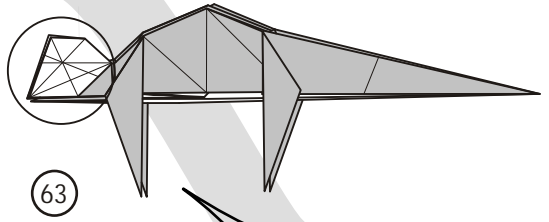

63

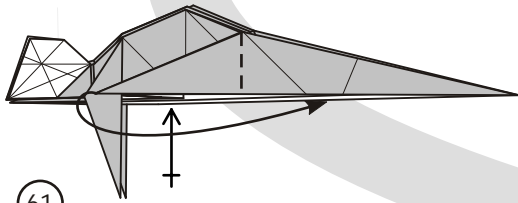

61

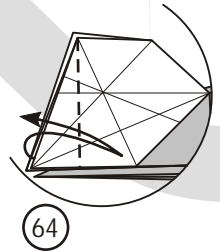

64

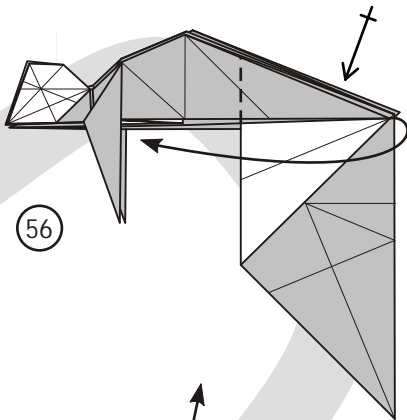

56

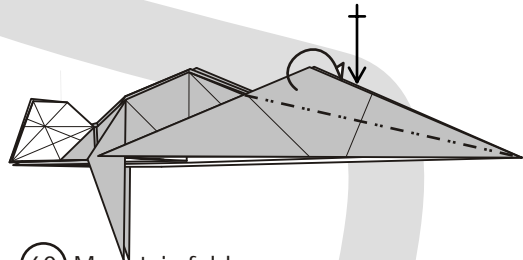

60 Mountain fold to inside model.

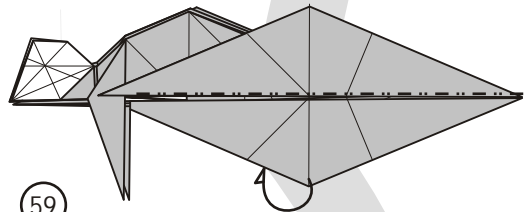

59

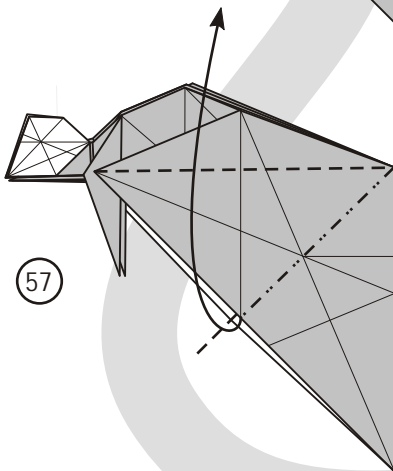

57

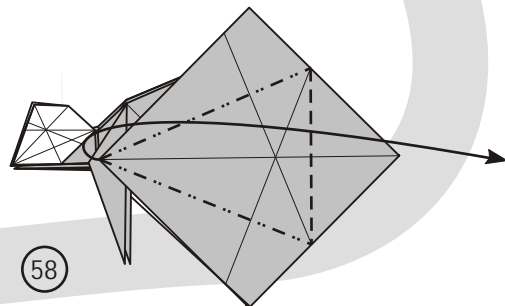

58

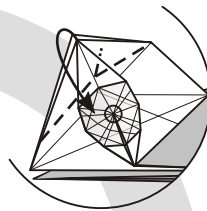
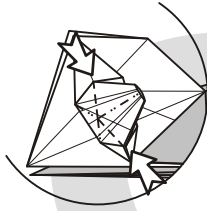
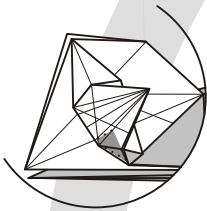
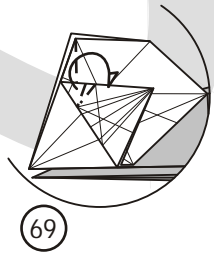
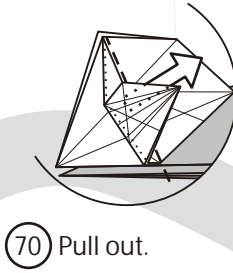
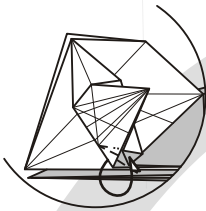
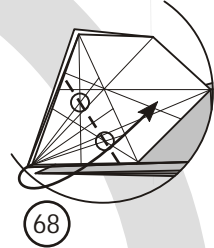
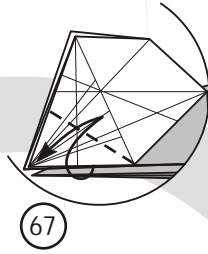
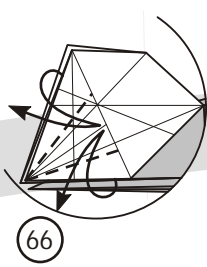
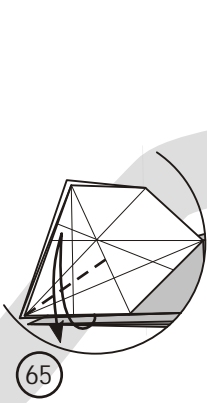

72) Unsink inside layer.

77) Make 3d eye.

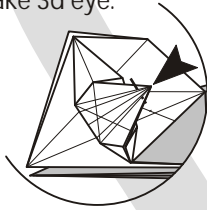
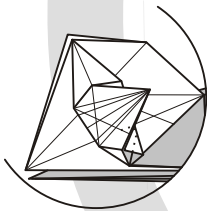

78)

64-78

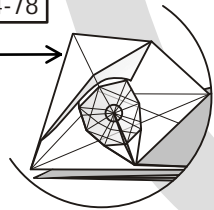

73) Like this.

76) Closed sink.

79)

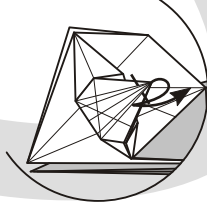
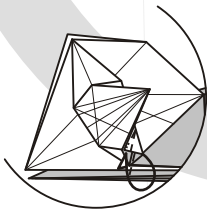

74)

75)

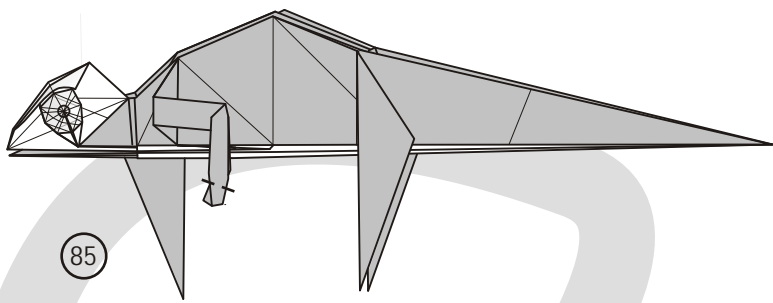

85

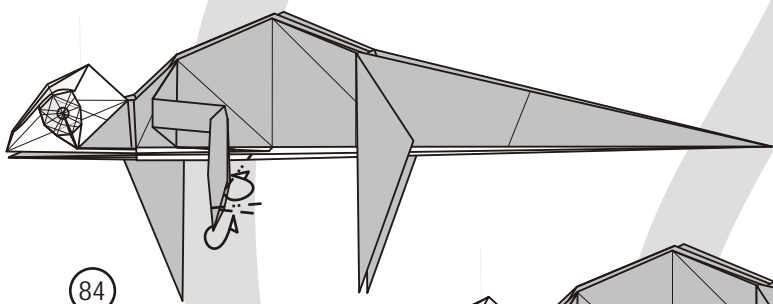

84

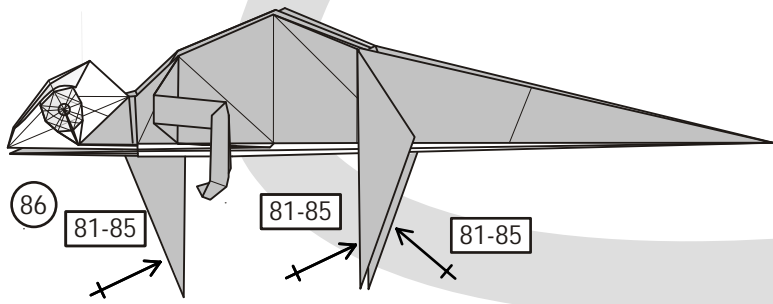

86

81-85

81-85

81-85

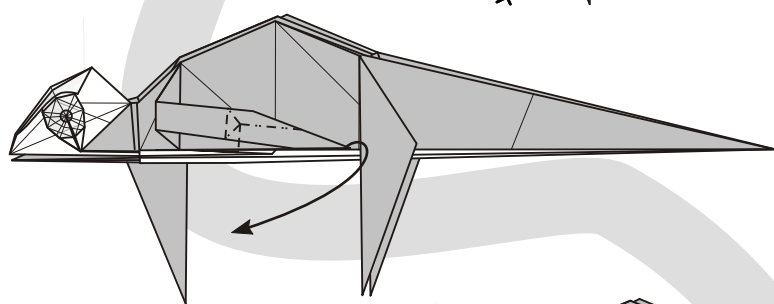

83 Rabbit ear.

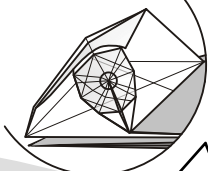

80

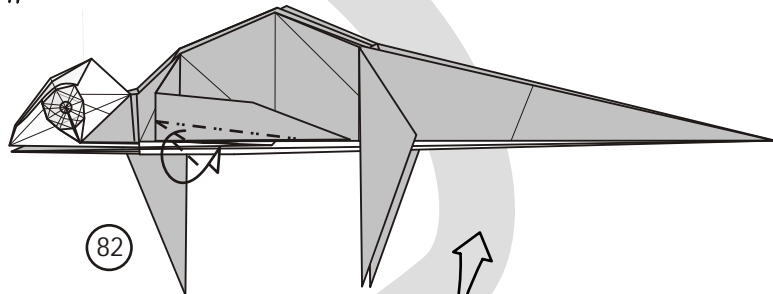

82

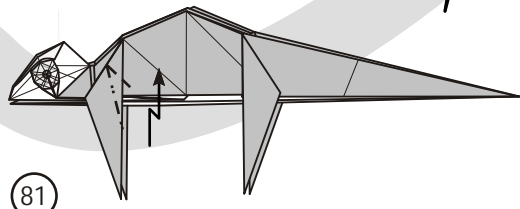

81

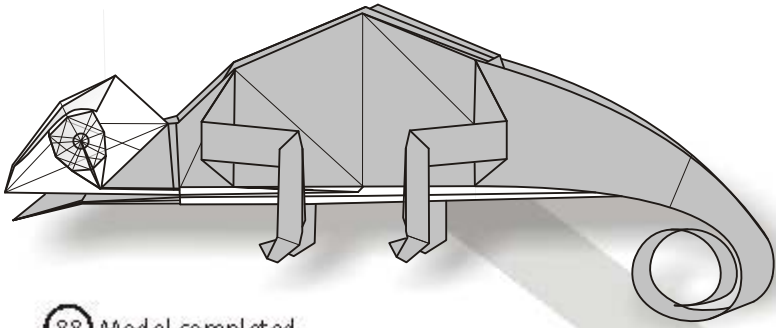

88 Model completed.

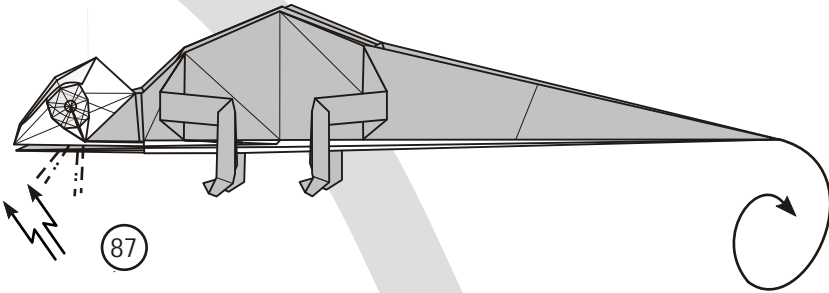

87