

Stellate Octahedron

Patricia Crawford (designer)

JC Nolan (diagrams)

©1973, 2013 - USA

Complex

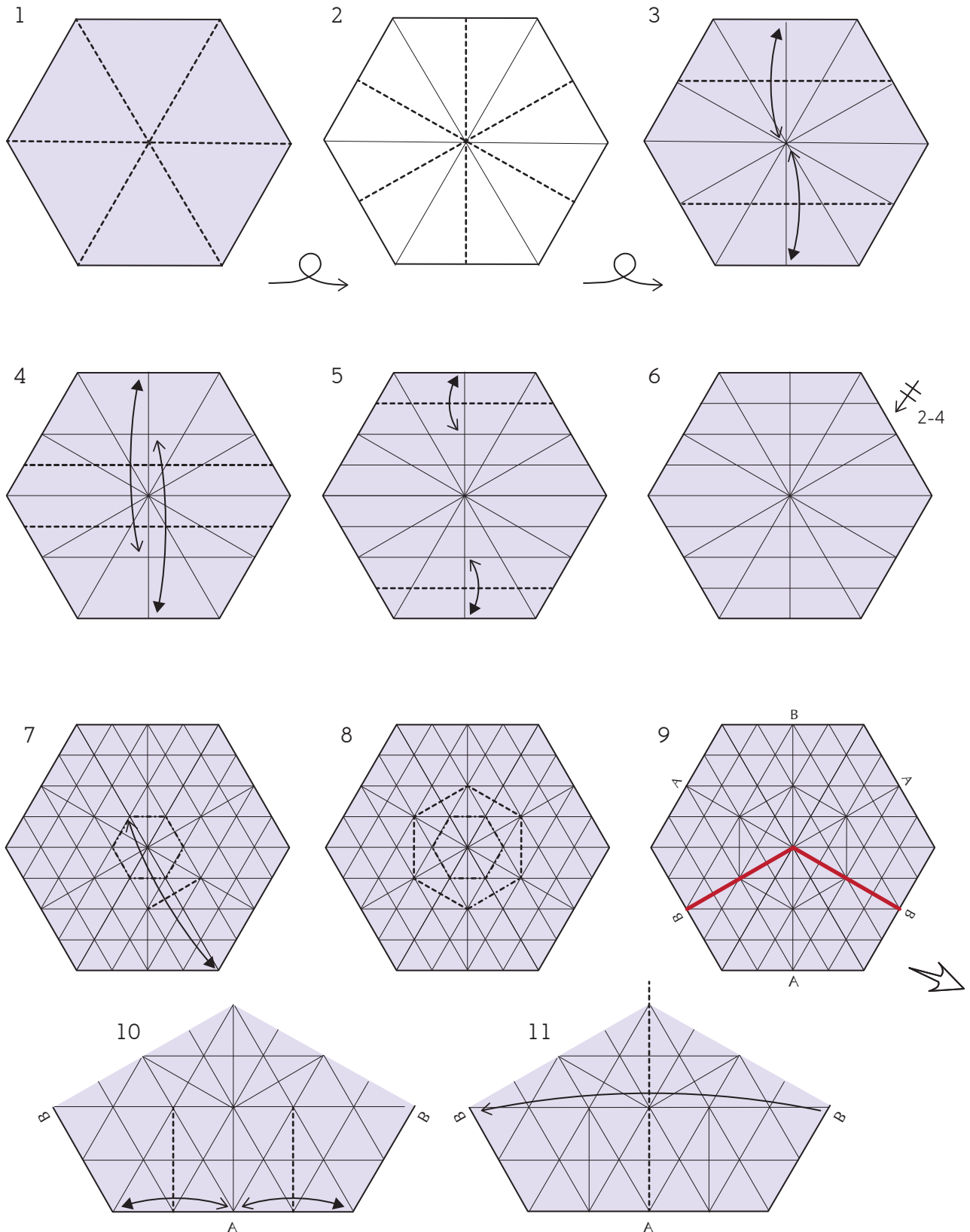

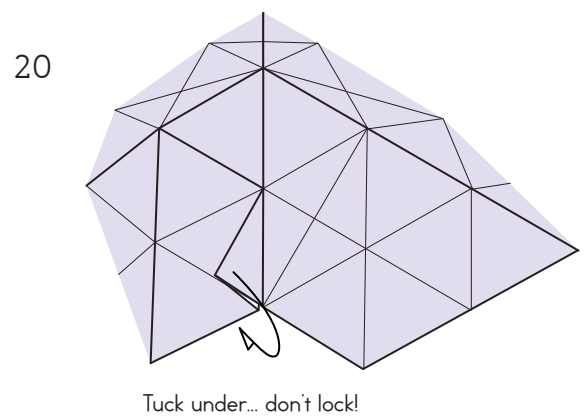
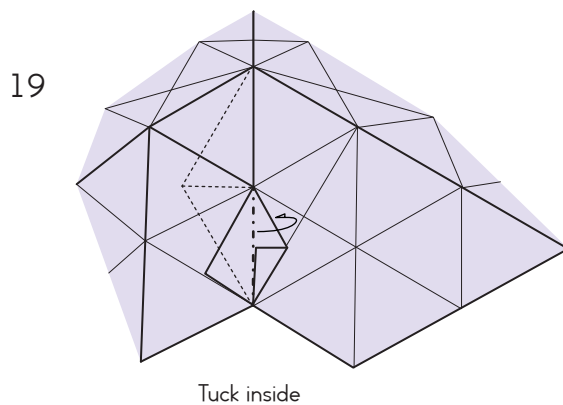
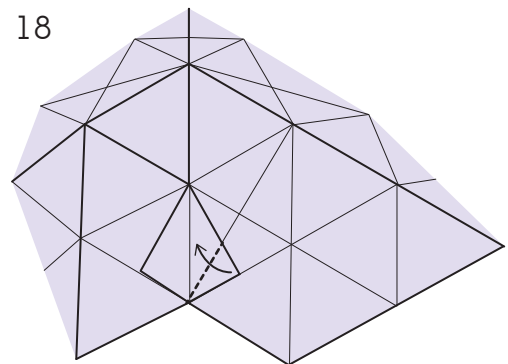
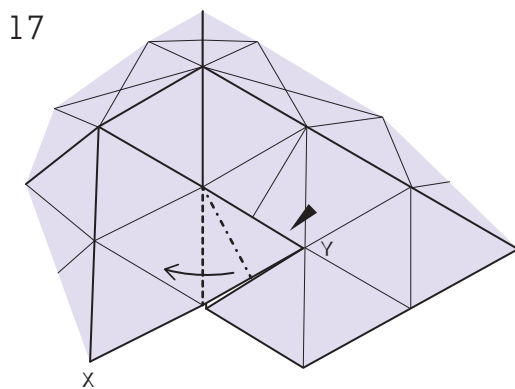
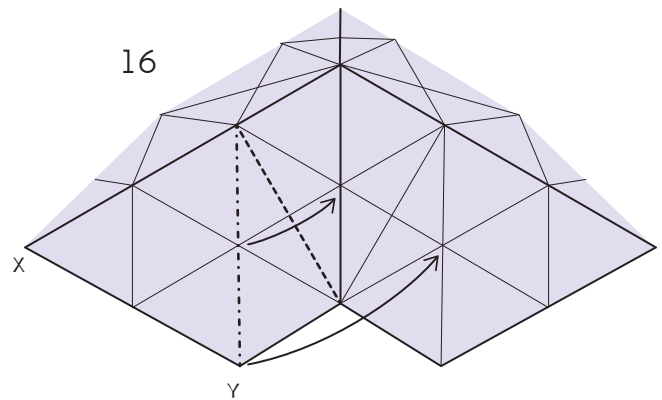
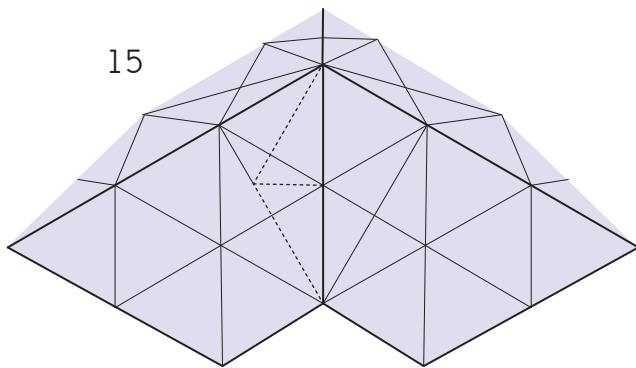
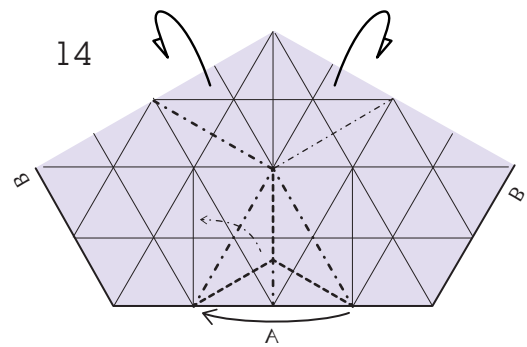
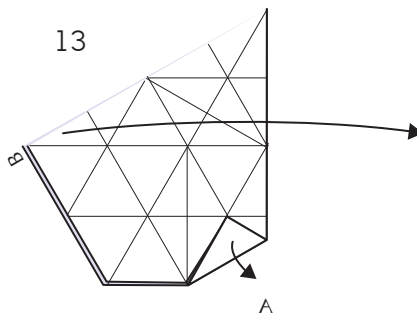
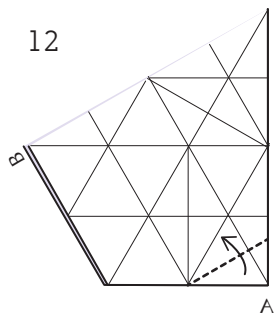

21

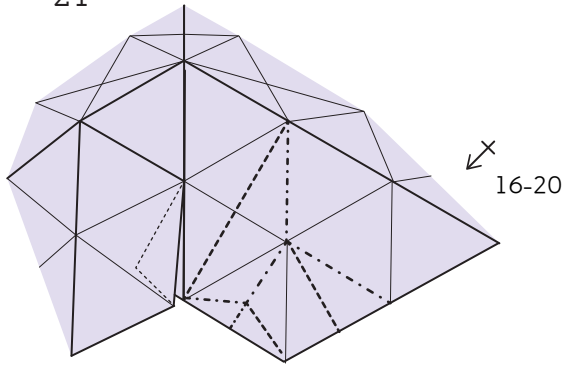

22

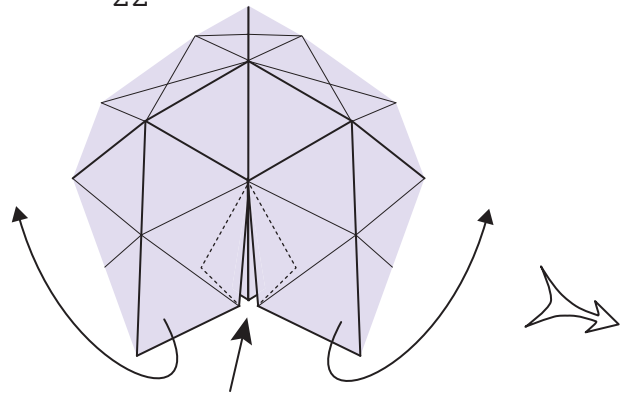

Important! Note that the upper flaps are not locked

23

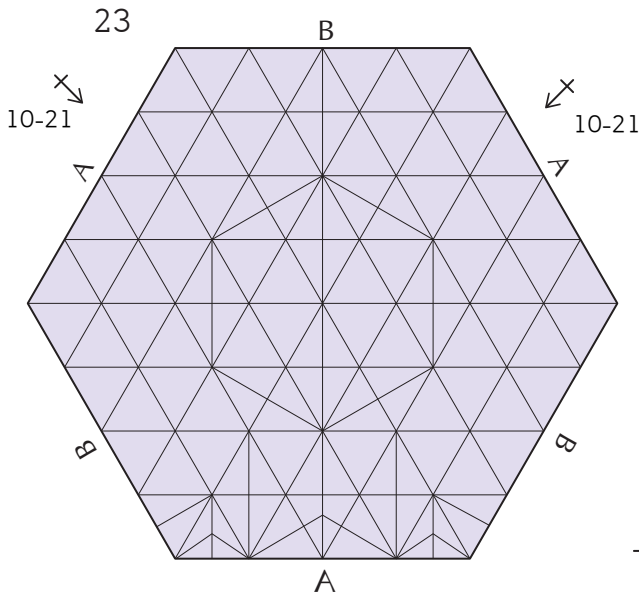

24

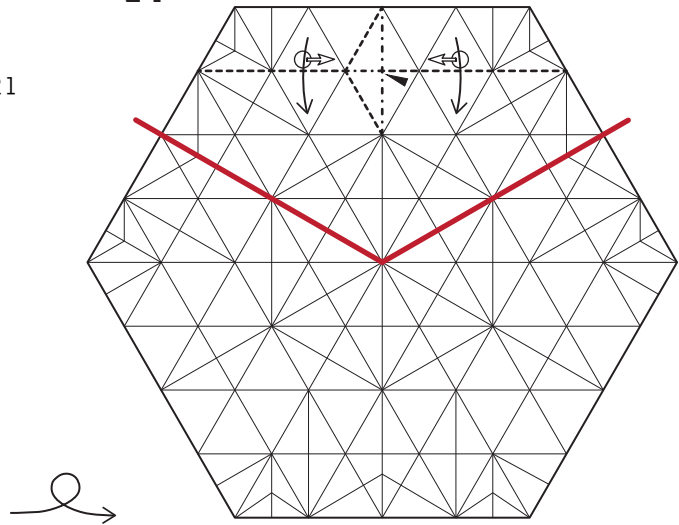

25

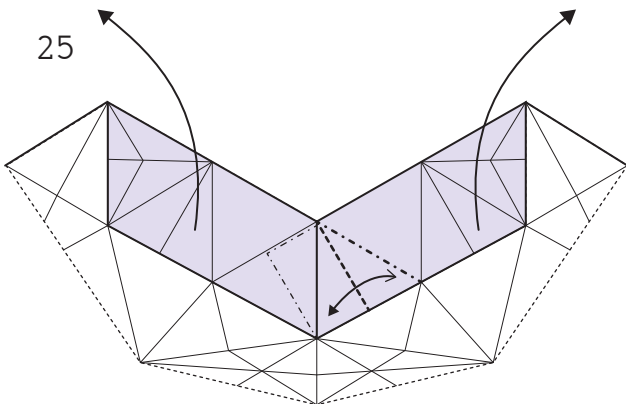

26

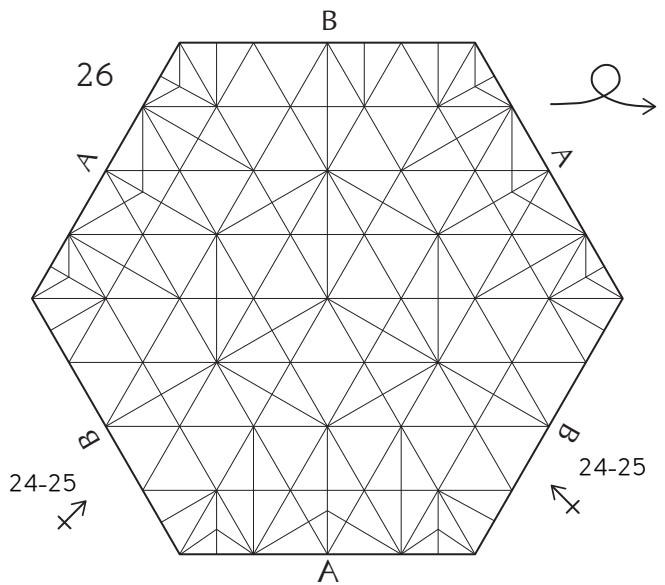

27

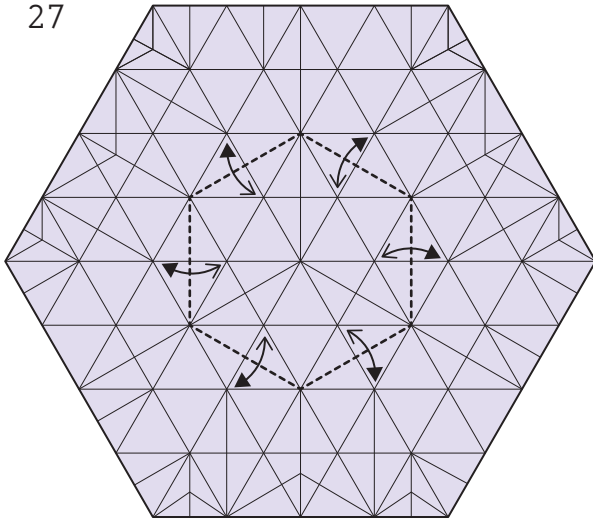

28

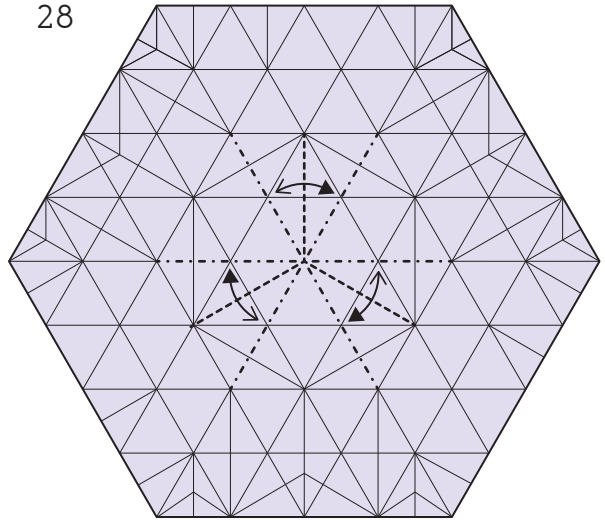

29

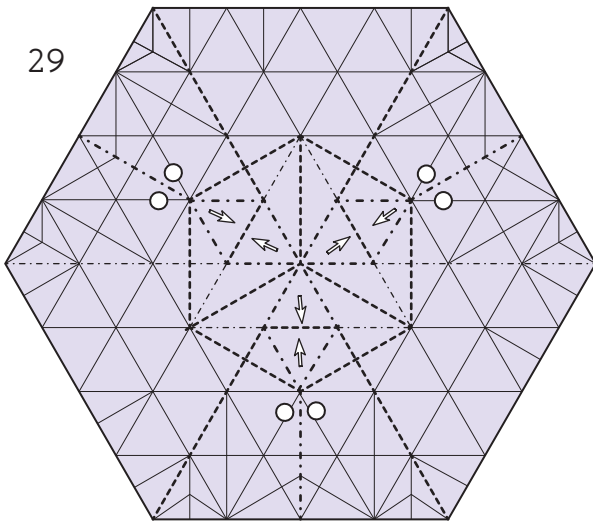

30

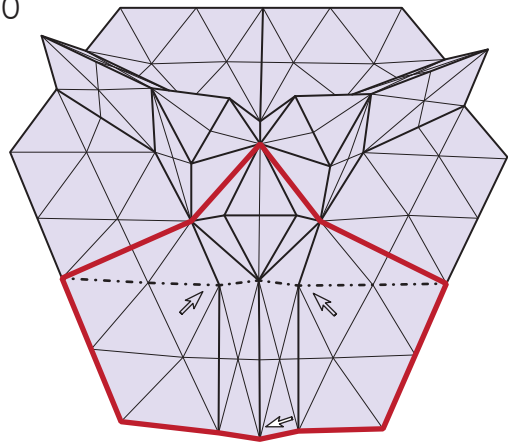

Flatten out by popping up from underneath

31

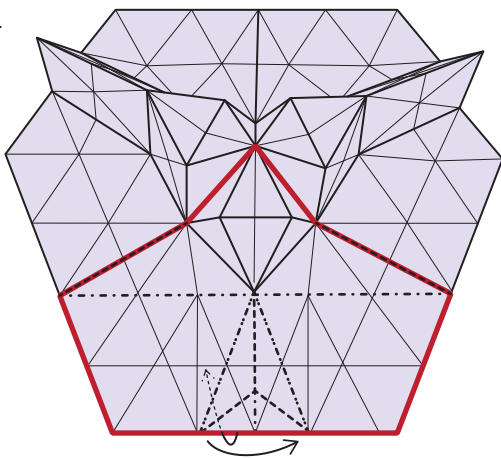

Now, re-execute steps 14-22

32

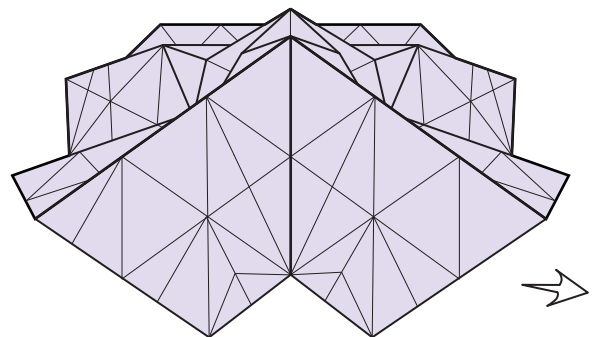

33

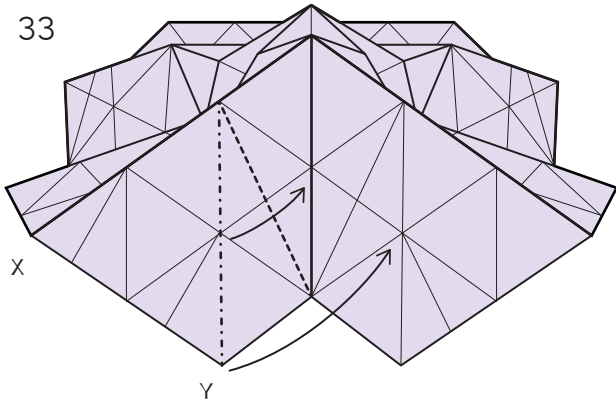

34

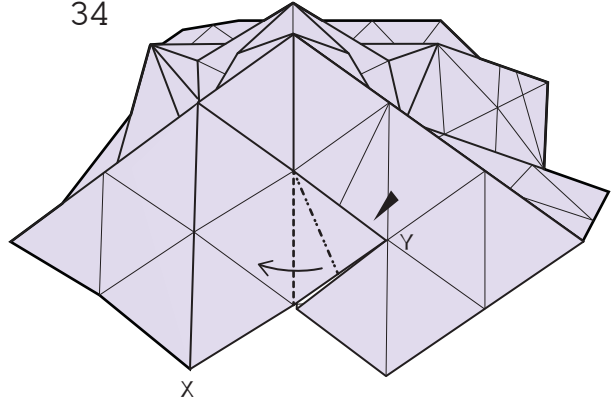

35

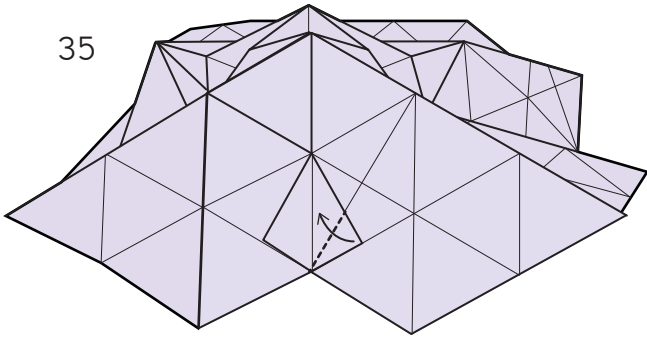

36

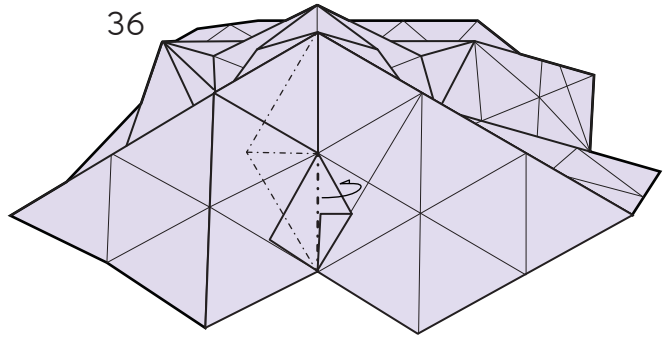

37

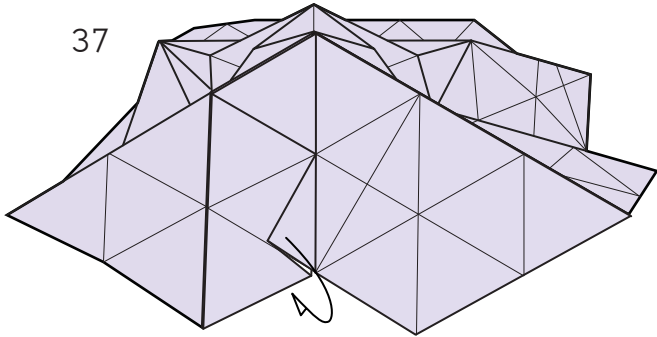

38

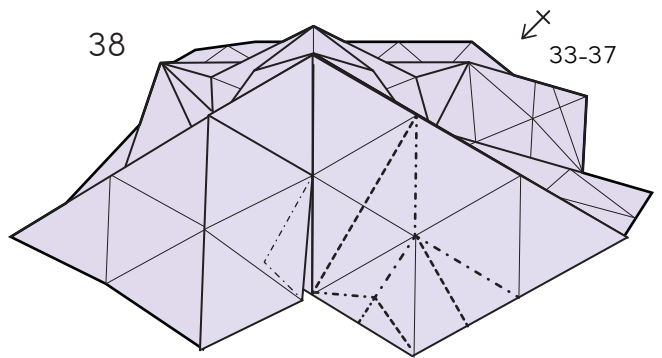

39

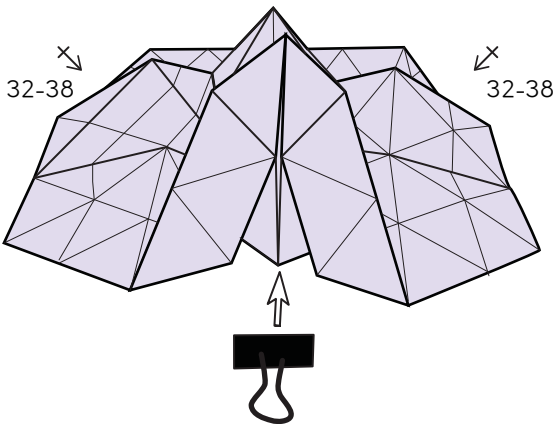

40

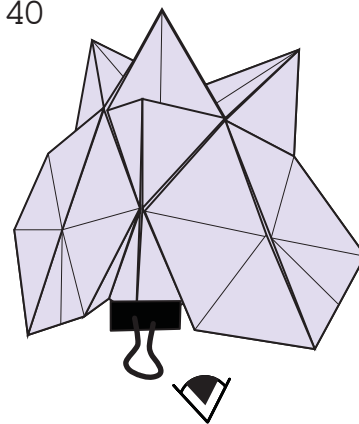

41

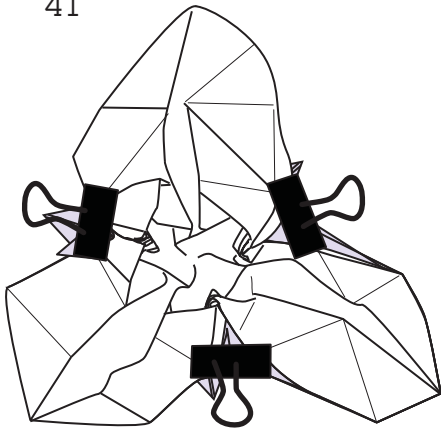

42

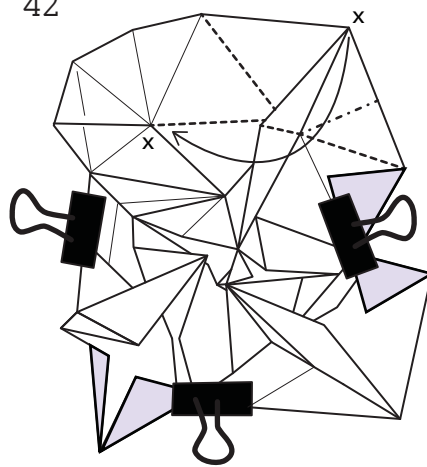

43

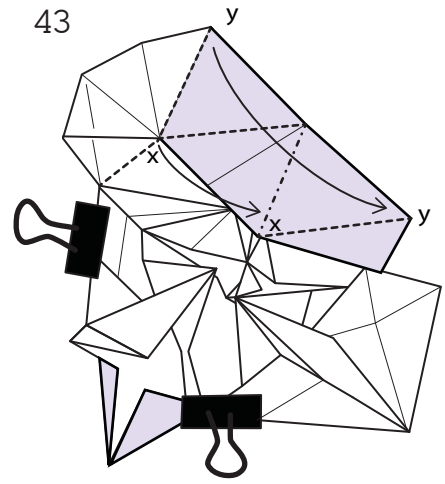

44

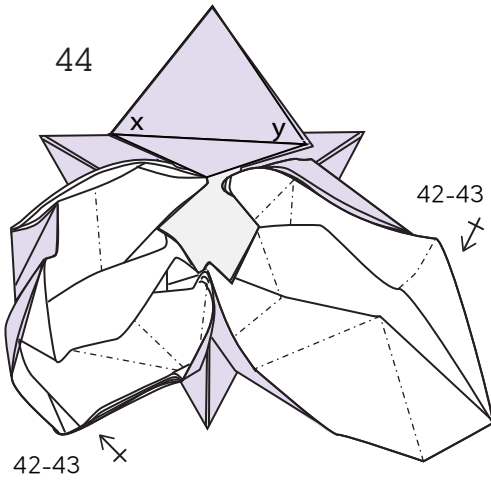

45

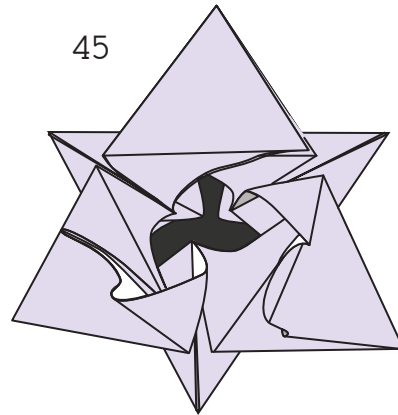

46

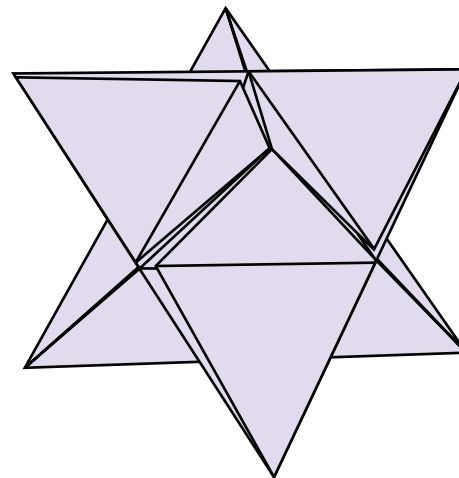
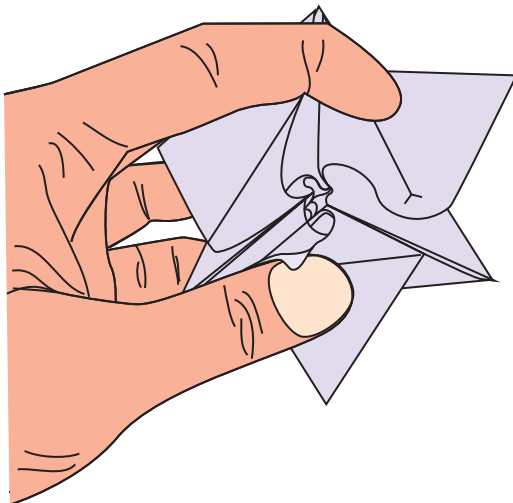

Hexagon from Square I

Fred Rohm (designer)

JC Nolan (diagrams)

Circa 1973 - USA

Beginner

1

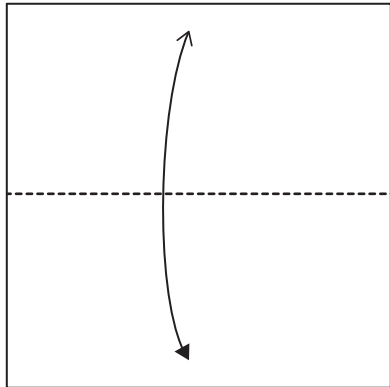

2

Super Soft

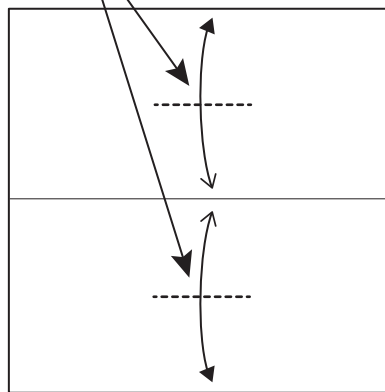

3

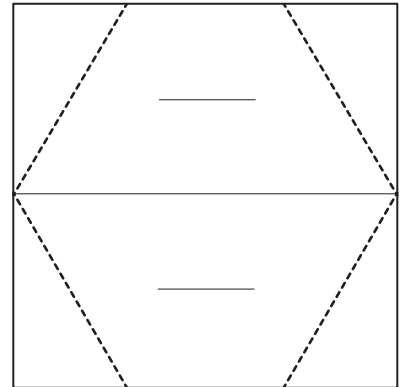

4

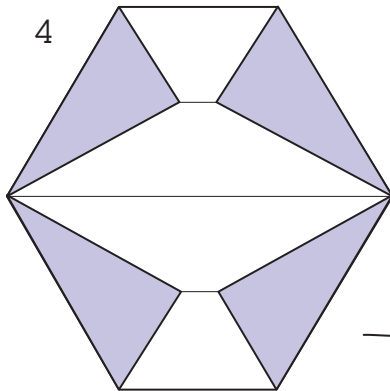

5

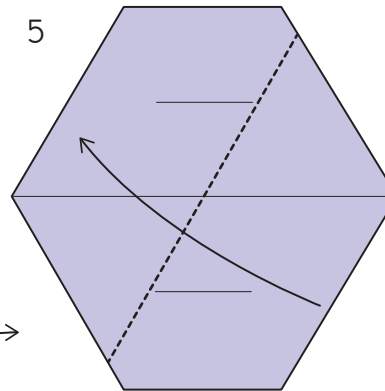

6

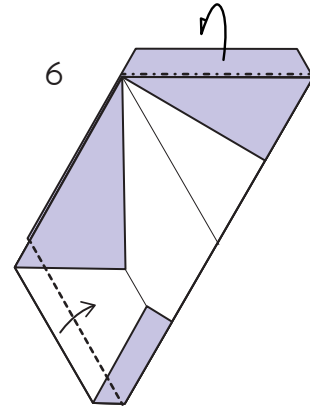

7

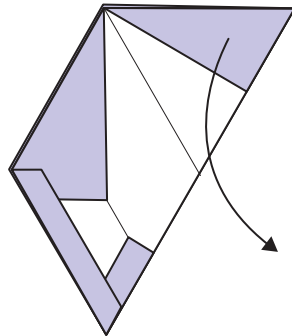

8

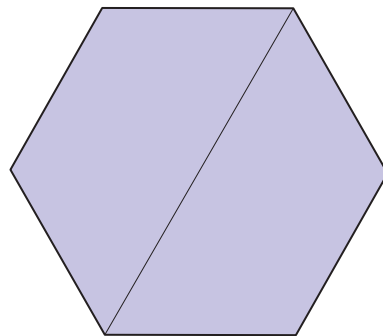

9

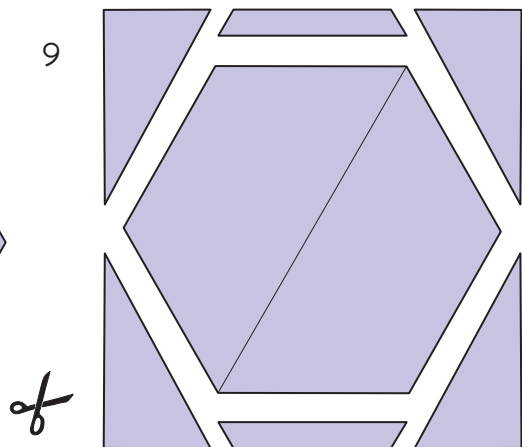

Hexagon from Square II

Patricia Crawford (designer)

JC Nolan (diagrams)

Circa 1973 - USA

Advanced Beginner

