

# VAMPIRE BAT

\*\*\*\*\*

## DESIGN AND DIAGRAM INFO:

Author: Phạm Minh Thiên Thành  
Diagram: Phạm Minh Thiên Thành  
Paper: 40x40 (cm)  
Time: 3 hours  
Difficulty : \*\*\*\*\*

Copyright © Phạm Minh Thiên Thành  
VIETNAM- 10/25/2017

<https://www.flickr.com/photos/141717226@N03/>

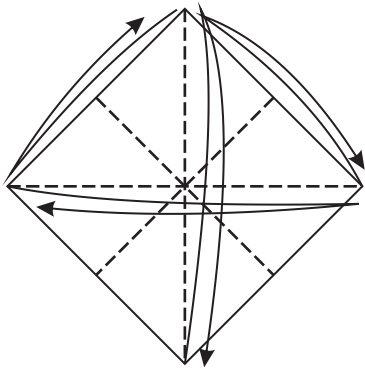

1.

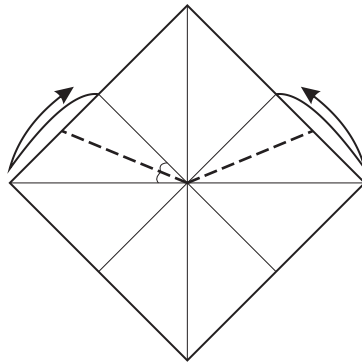

2.

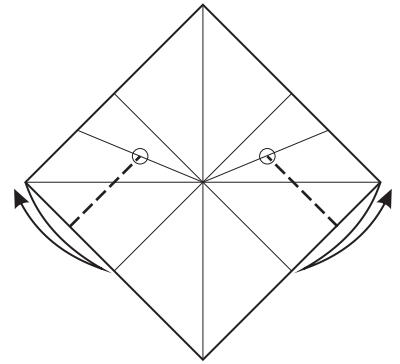

3.

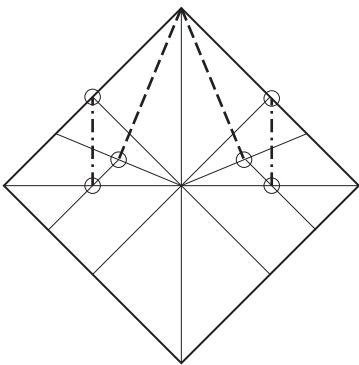

4.

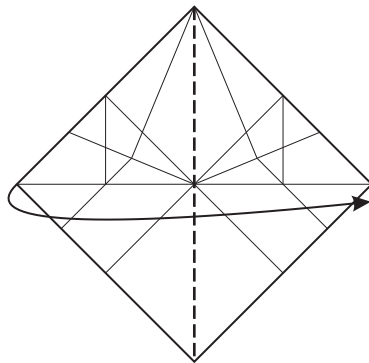

5.

90  

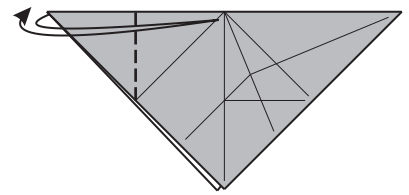
6.

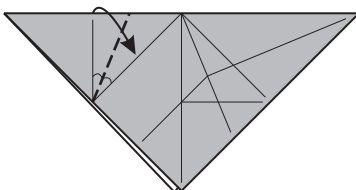

7.

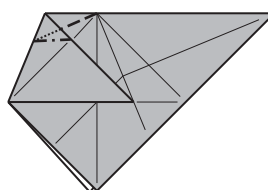

8.

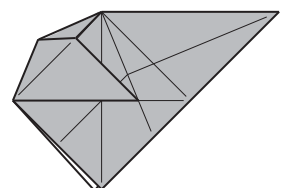

9. return in step 6

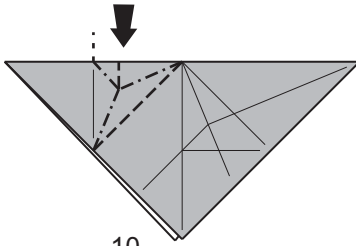

10.

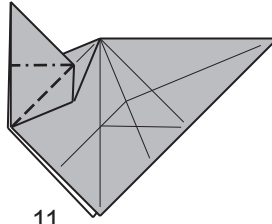

11.

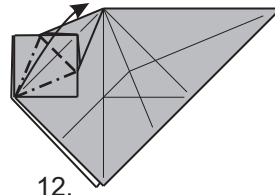

12.

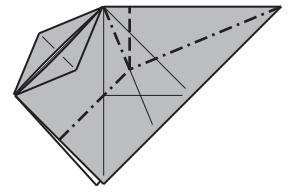

13.

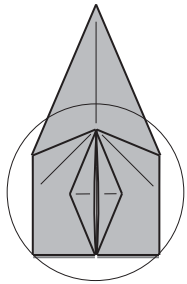

14. zoom in

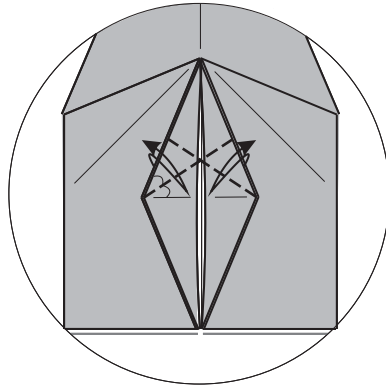

15.

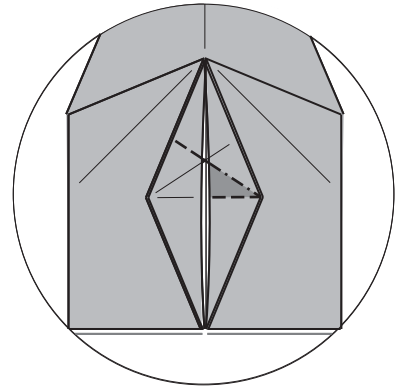

16.

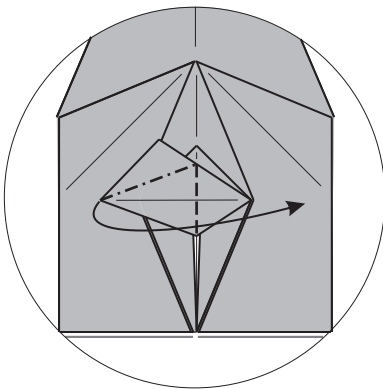

17.

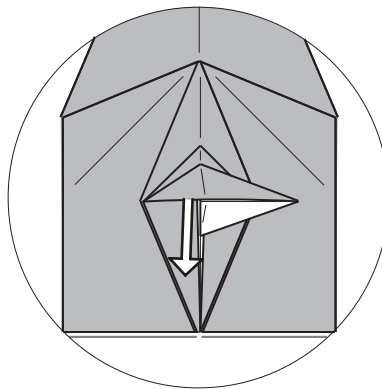

18. pull out the inside layer

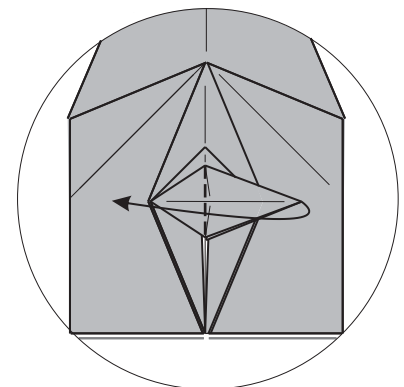

19.

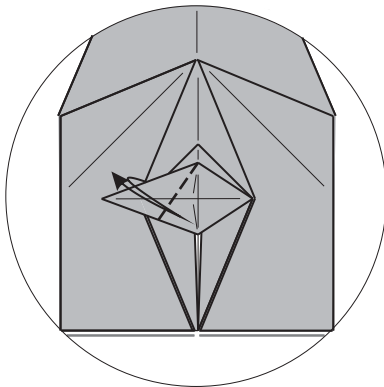

20.

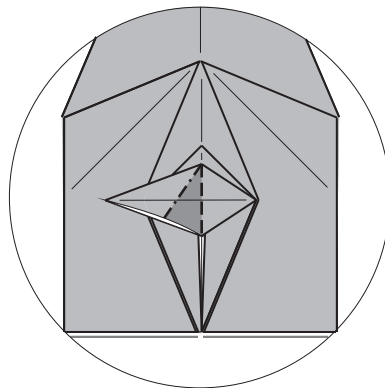

21.

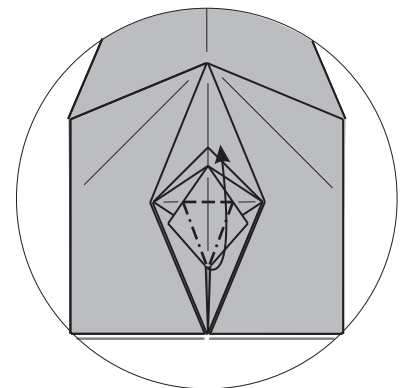

22.

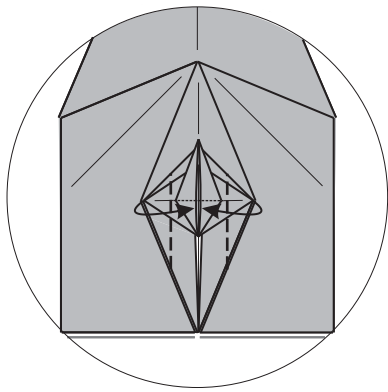

23. fold 1 layer

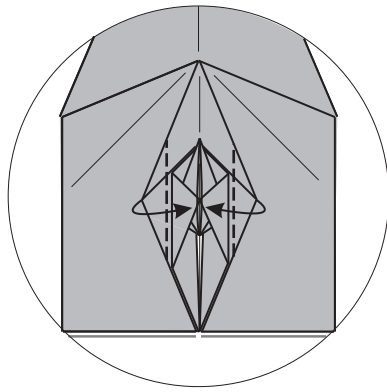

24. have a space

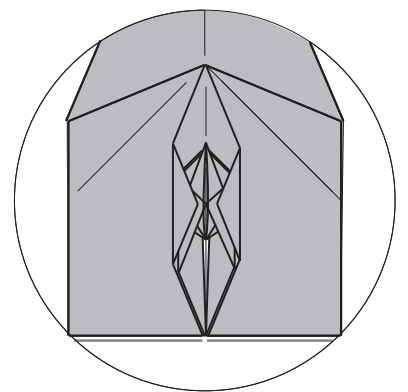

25. return in step 23

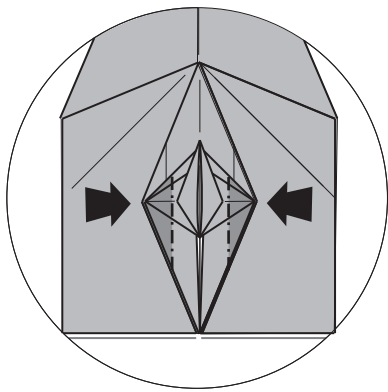

26. sink 1 layer

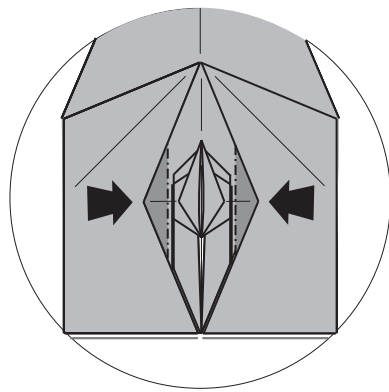

27. sink again

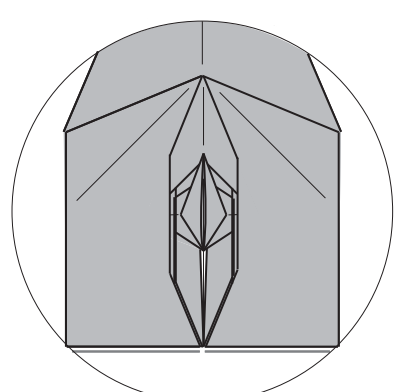

28. zoom out

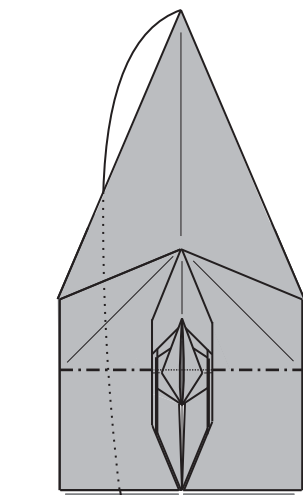

29.

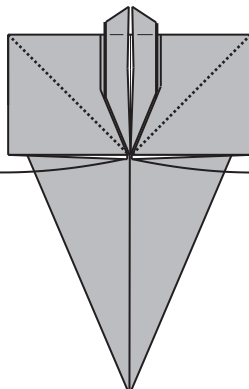

30.

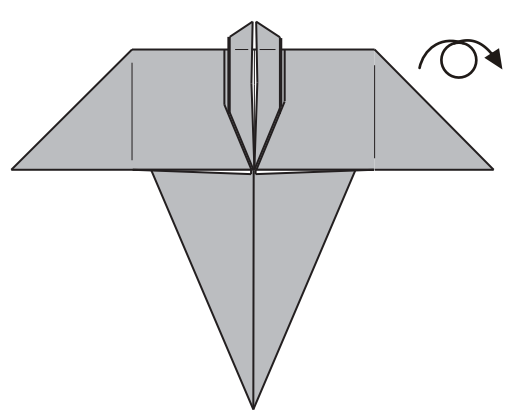

31.

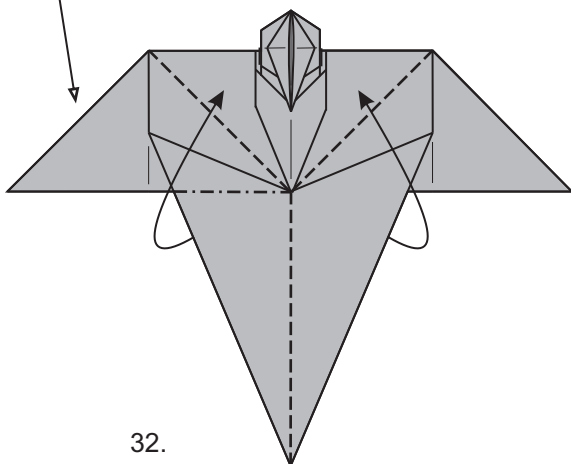

32.

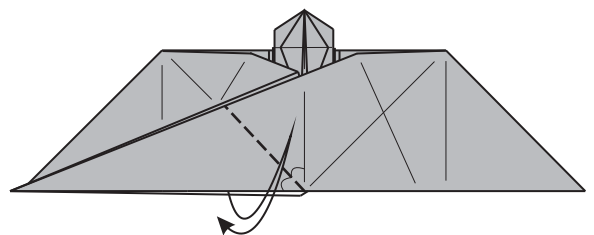

33.

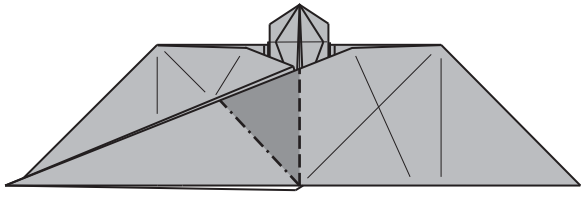

34.

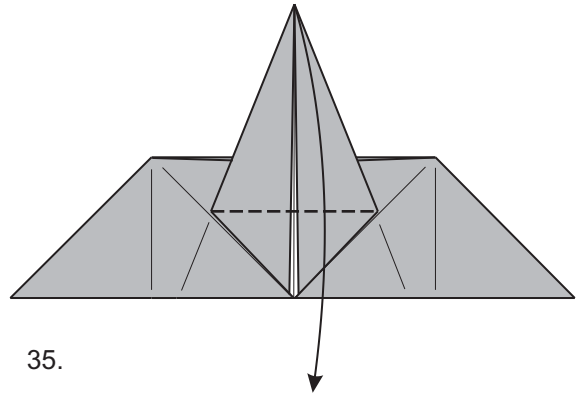

35.

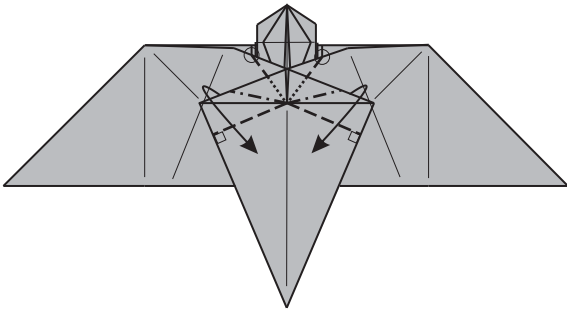

36. look careful

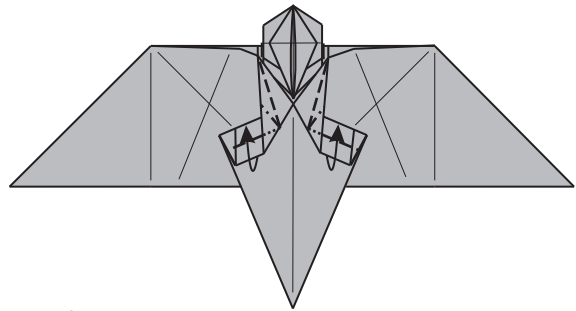

37.

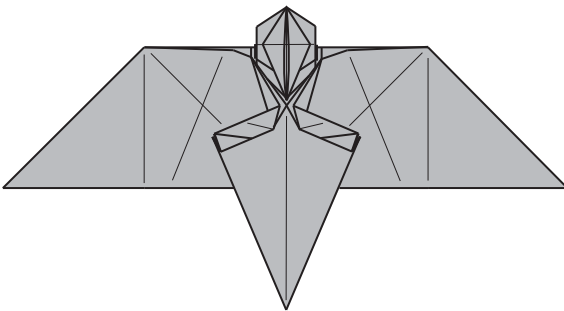

38. return in step 32.

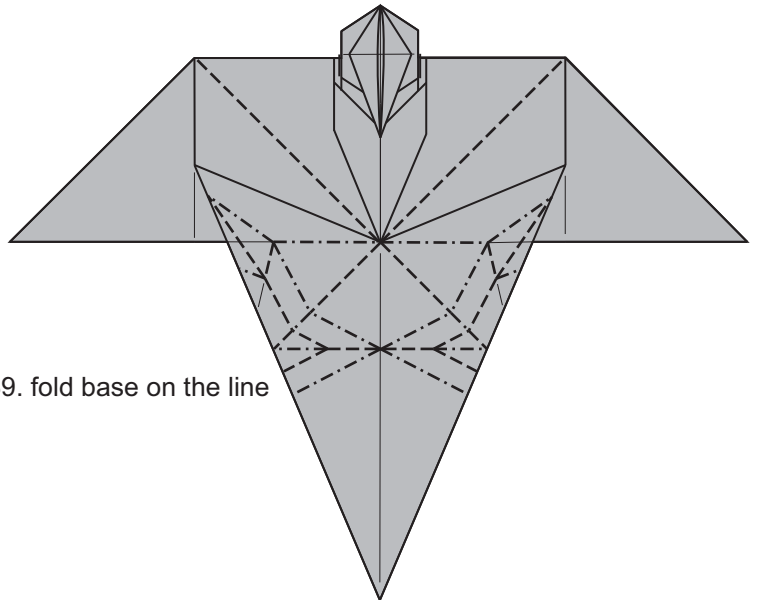

39. fold base on the line

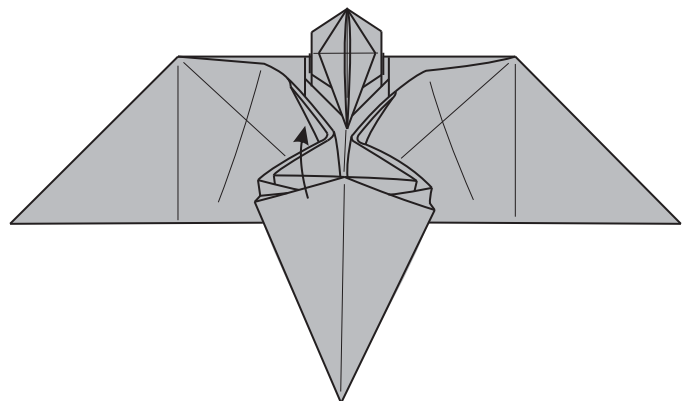
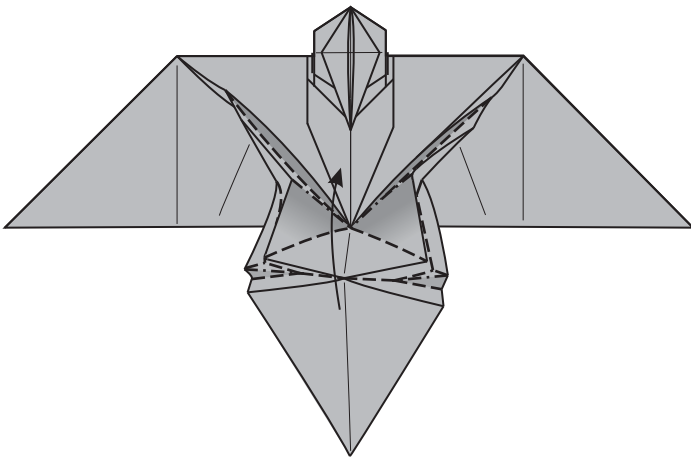

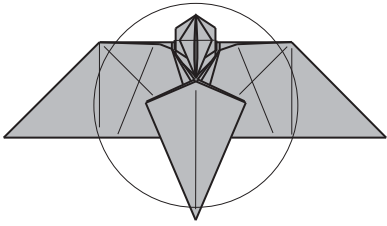

40. zoom in

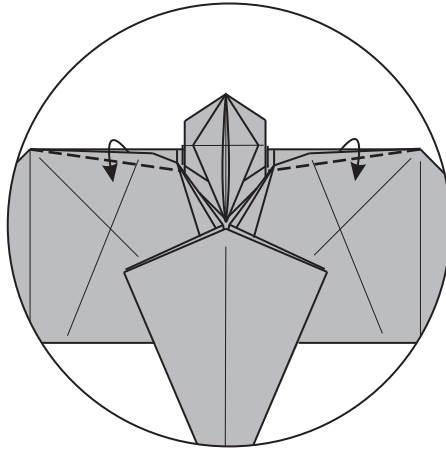

41.

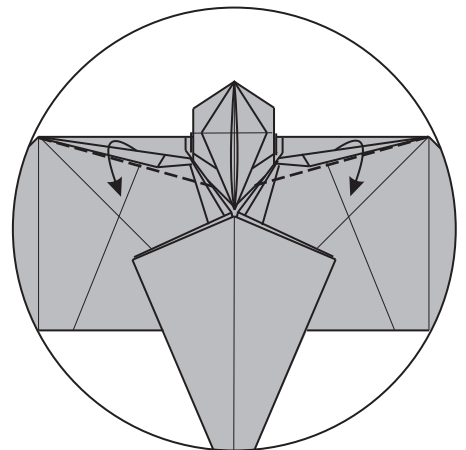

42.

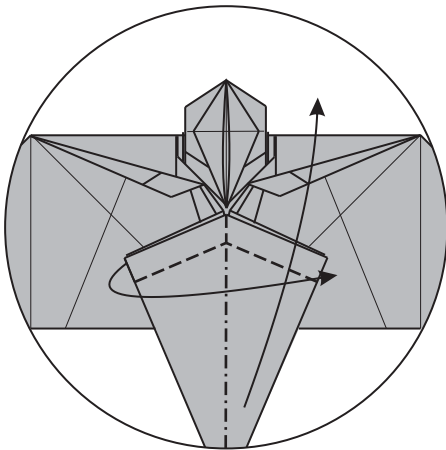

43.

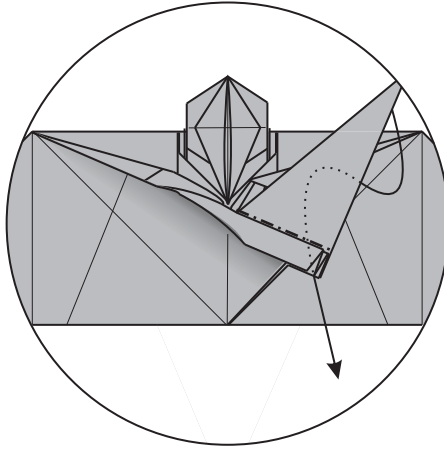

44.

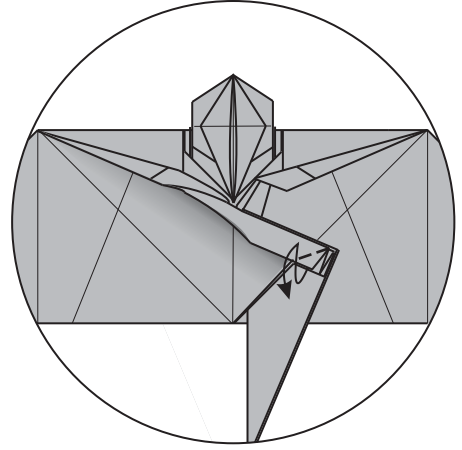

45.

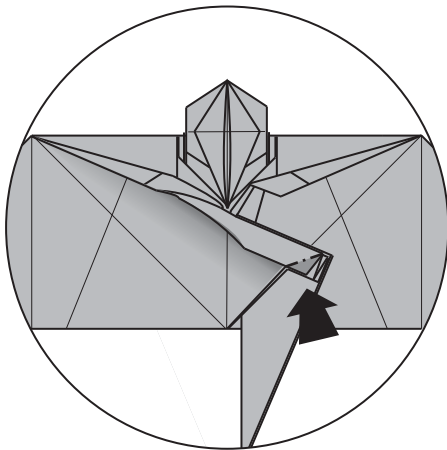

46.

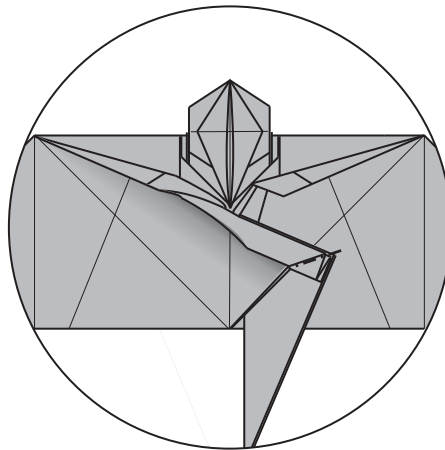

47.

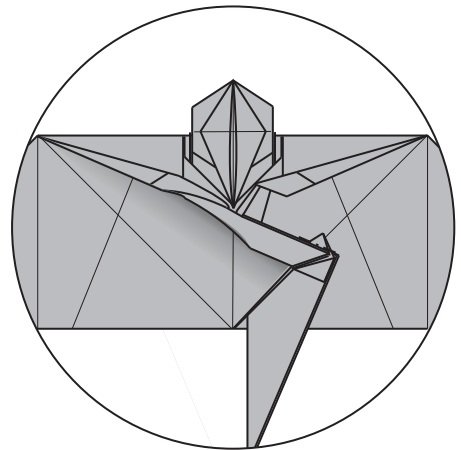

48.

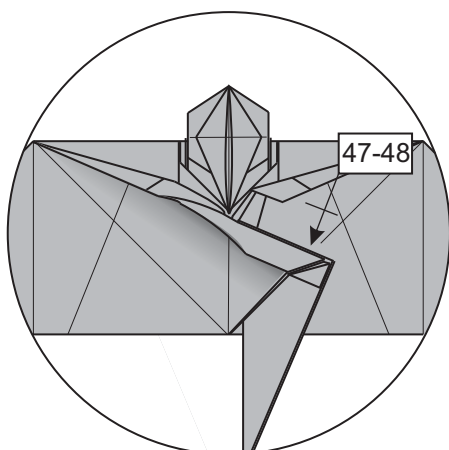

49. repeat on the final layer

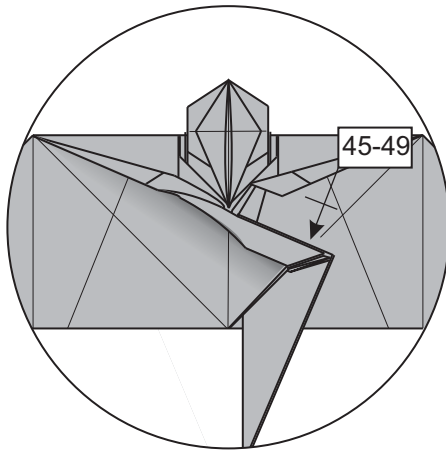

50. repeat on the right

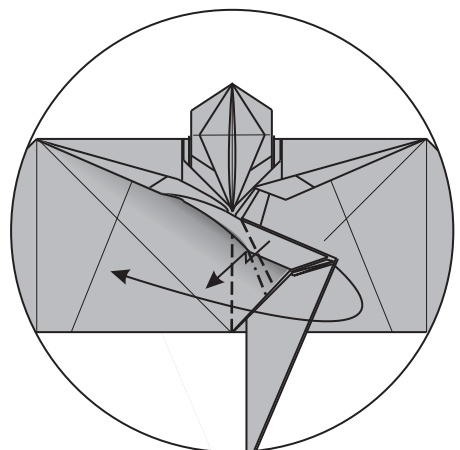

51.

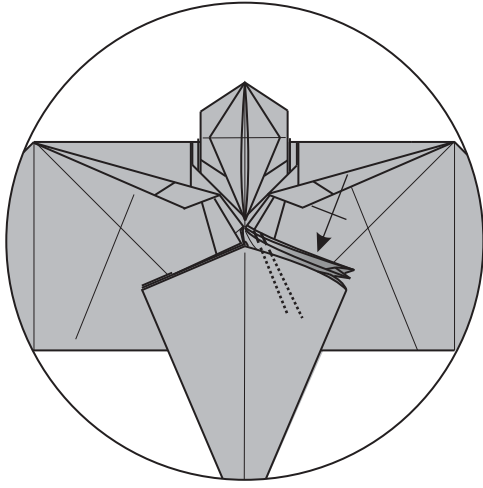

52. repeat on the right

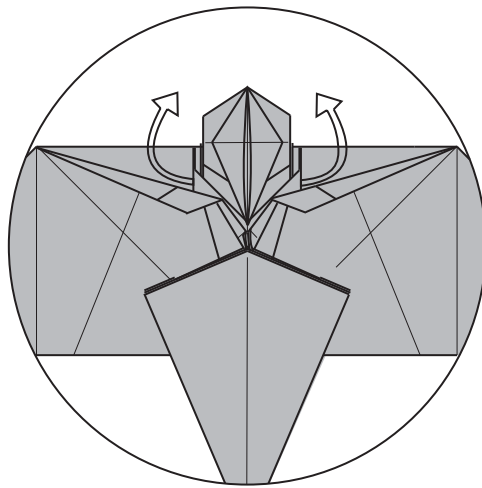

53. pull the under layer out

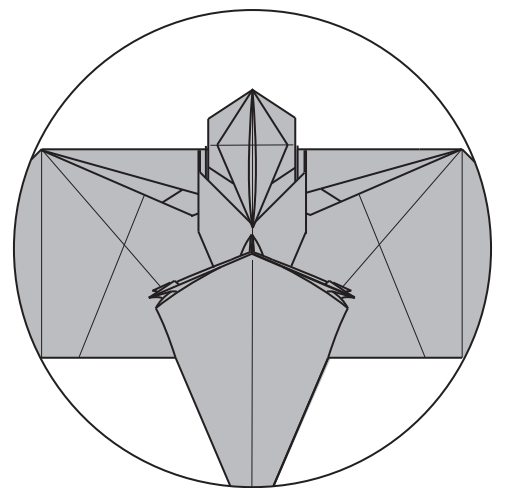

54. zoom out

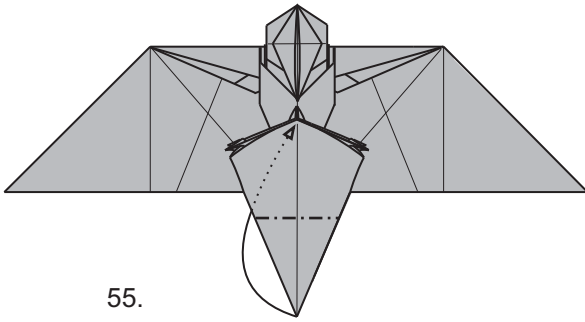

55.

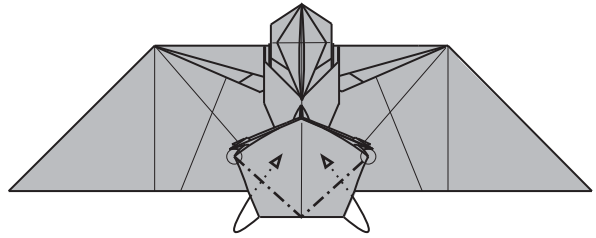

56.

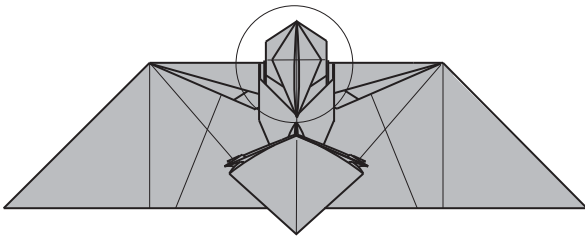

57. zoom in

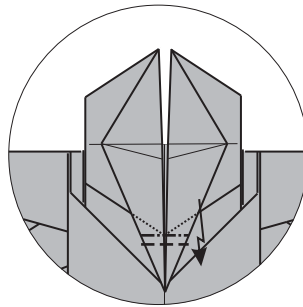

58.

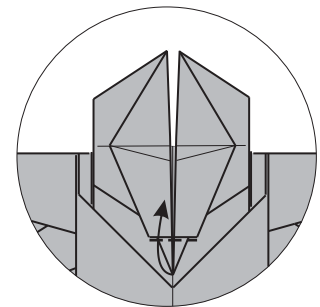

59.

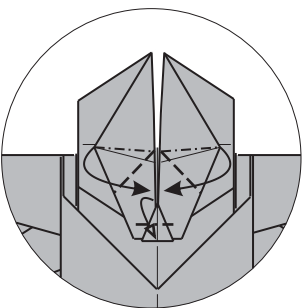

60.

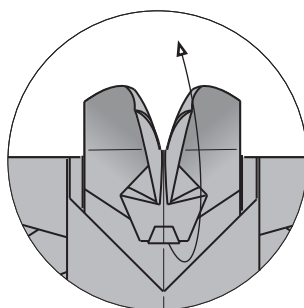

61.

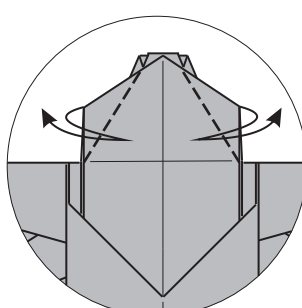

62

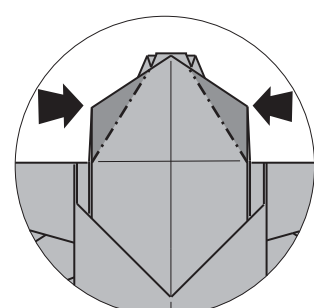

63. sink

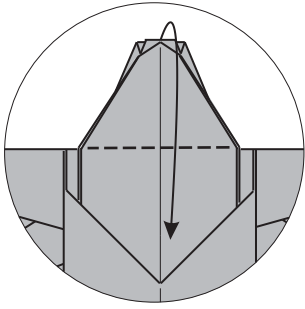

64.

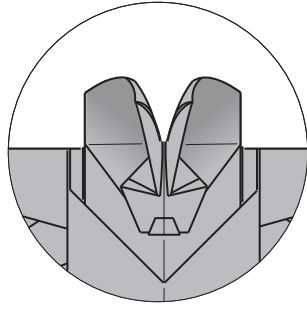

65. zoom out

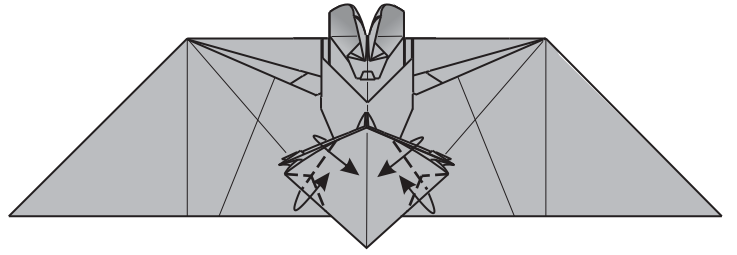

65.

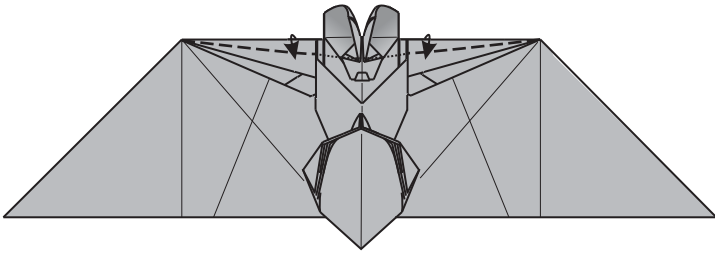

66.

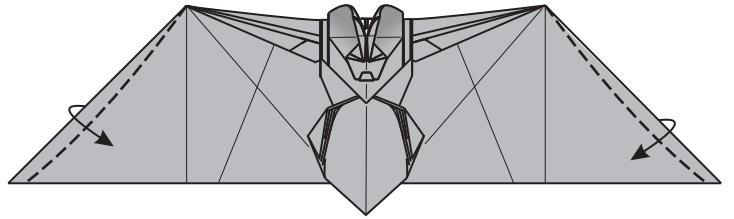

67.

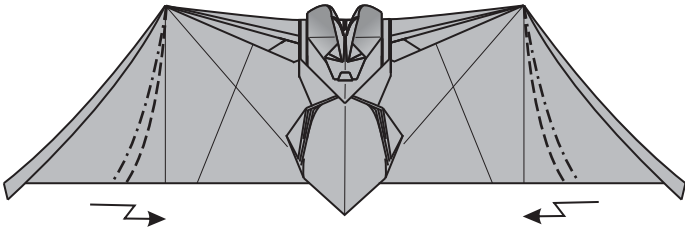

68.

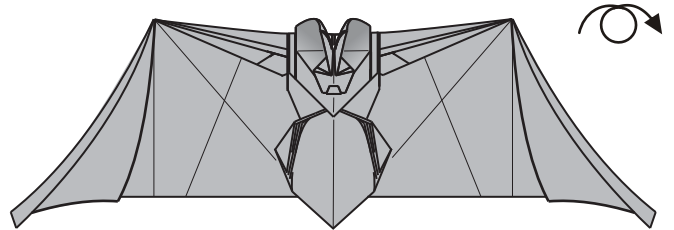

69.

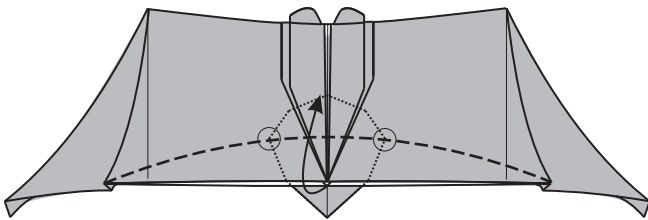

70.

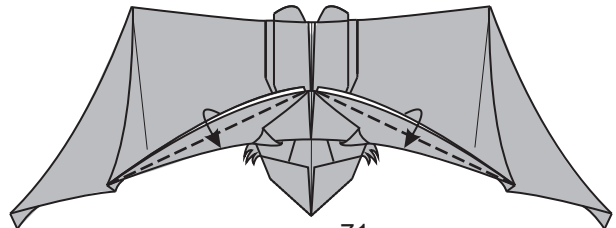

71.

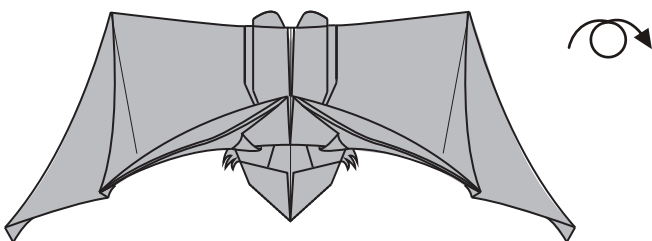

72.

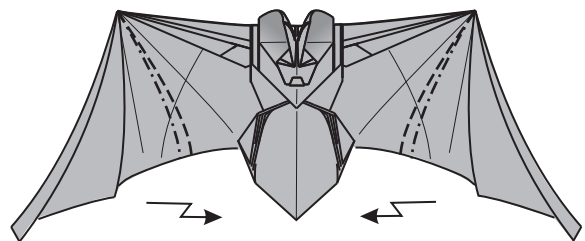

73.

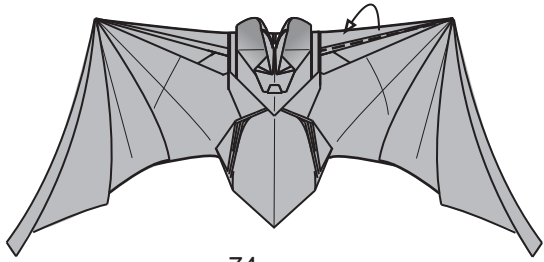

74.

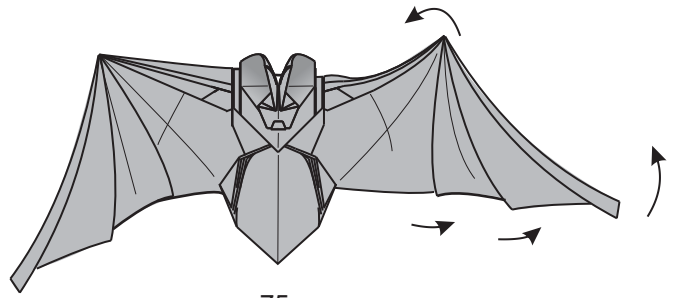

75

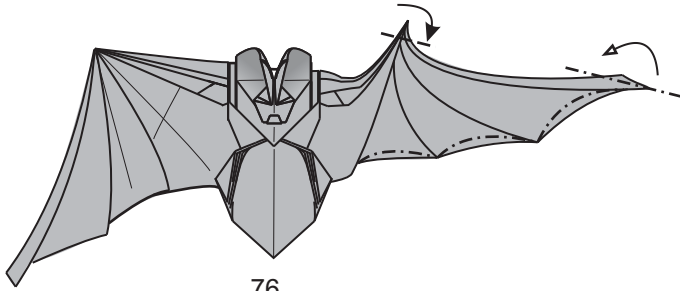

76.

74-76

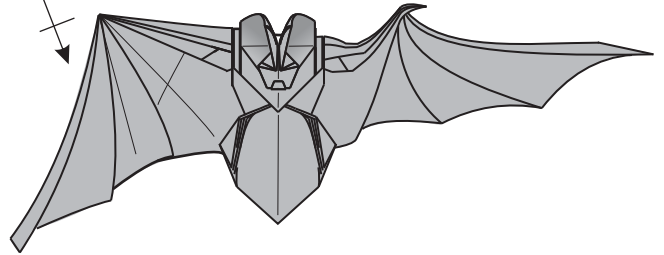

77. repeat on the left

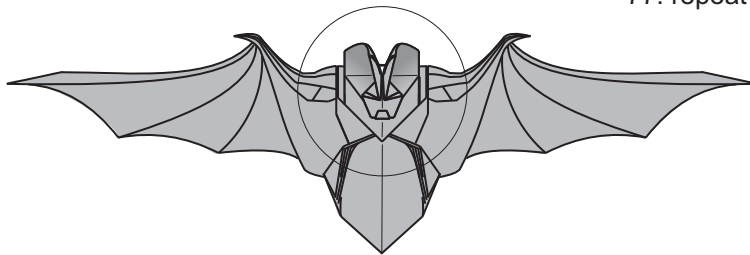

78. zoom in

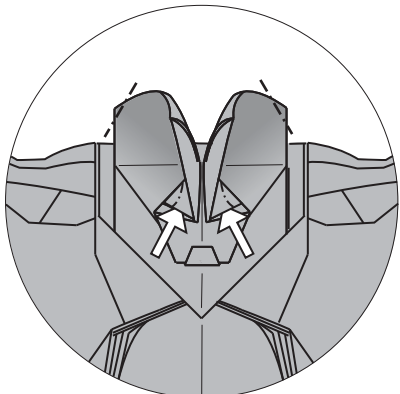

79.

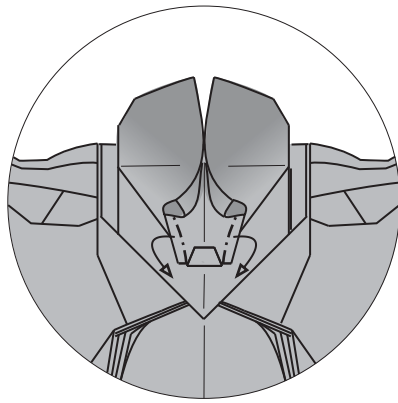

80.

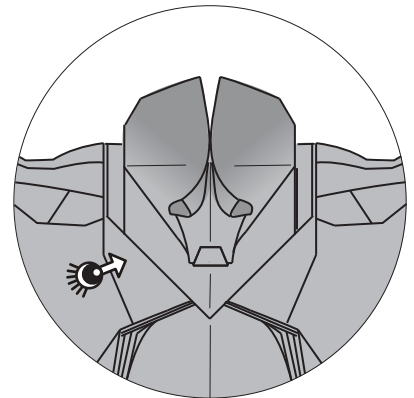

81.



82.

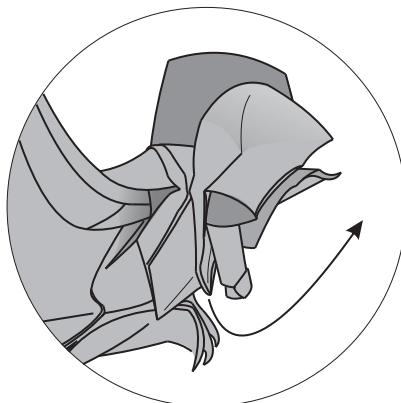

83.

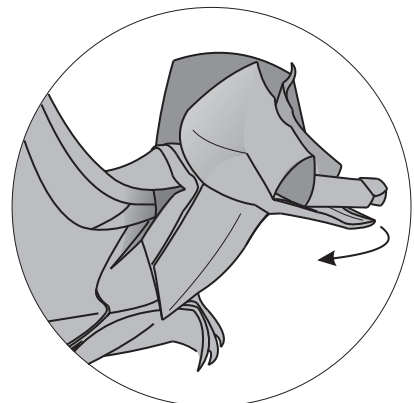

84.



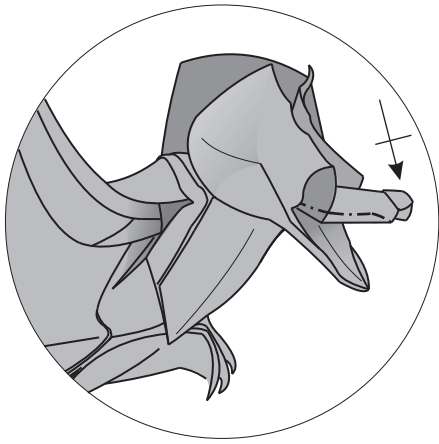

85.



86.



87.

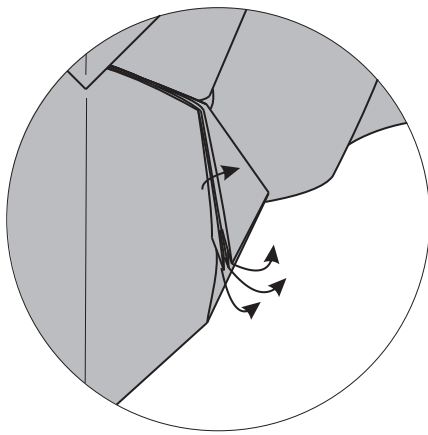

88. Fold and repeat on the left

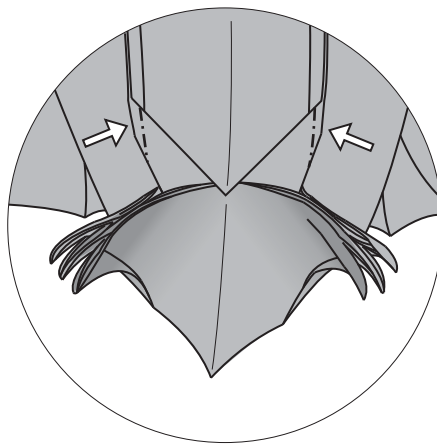

89.

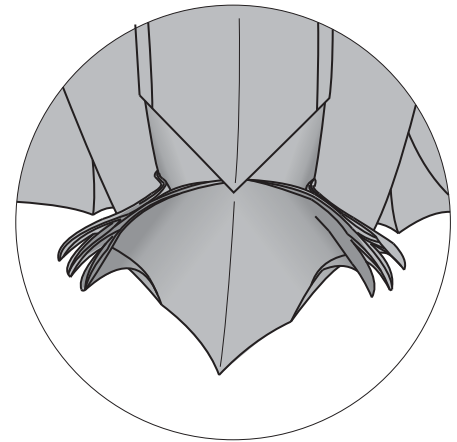

90.



91. Finished