

FIELD CRAB

Author: Phạm Minh Thiên Thành
 Diagram: Phạm Minh Thiên Thành

RECOMMENDED:

Size: 30x30 (cm)
 Paper: thin sheet of paper
 Time: 5 (hours)
 Difficulty : *****

Copyright © Phạm Minh Thiên Thành
 VIETNAM- 07/17/2017
<https://www.flickr.com/photos/141717226@N03/>

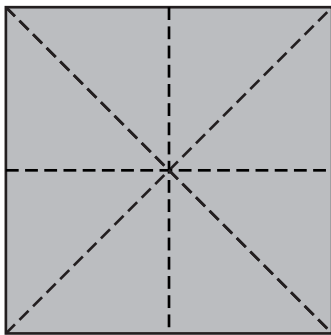
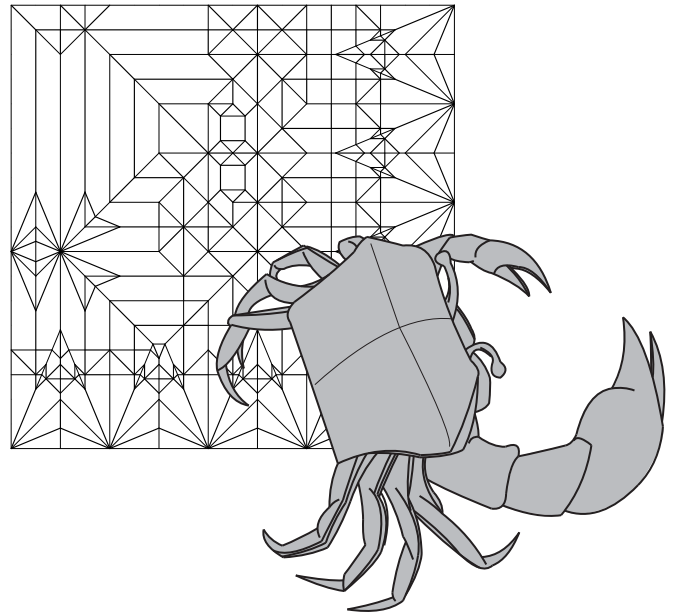

1. Crease as shown

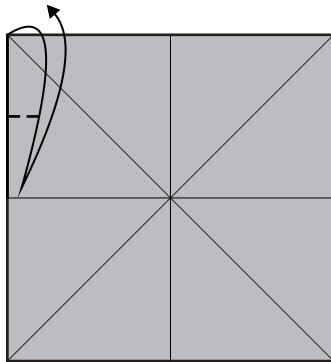

2. fold and unfold

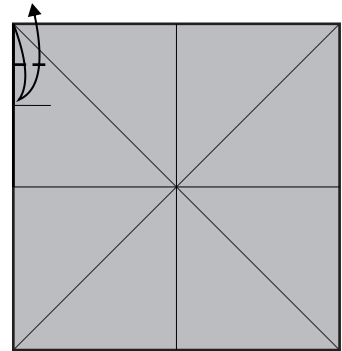

3. fold and unfold

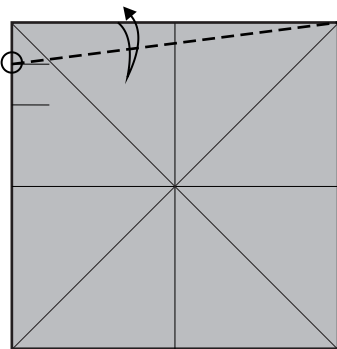

4. fold and unfold

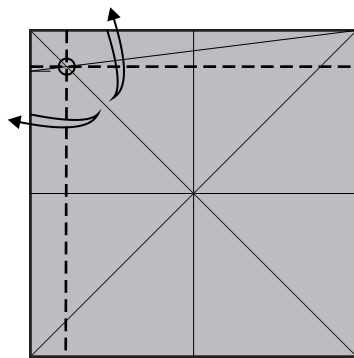

5.

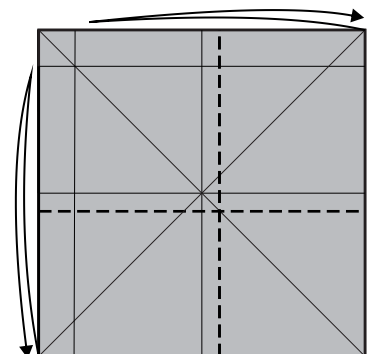

6.

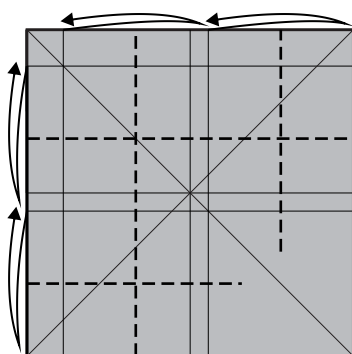

7.

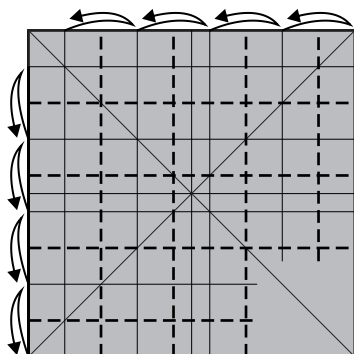

8. nice sections equal

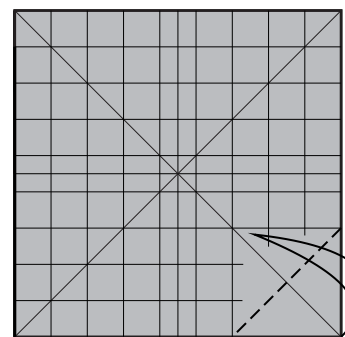

9. fold and unfold



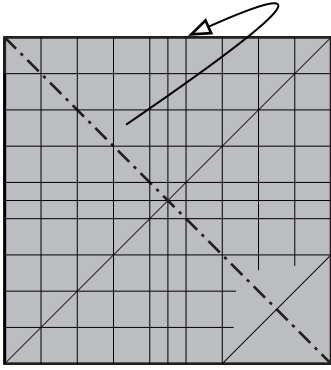

10. Fold paper backwards

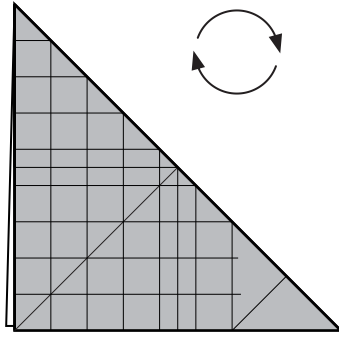

11. Rotate 90 degrees

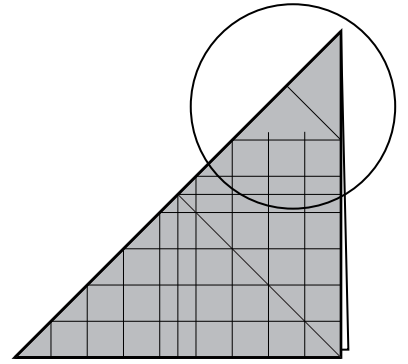

12. Zoom in

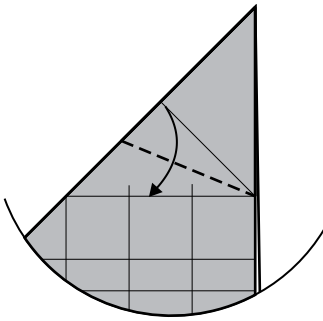

13. Valley fold

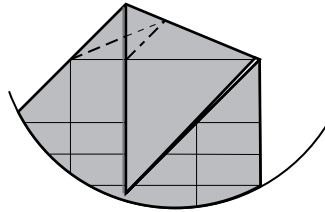

14. Fold inside

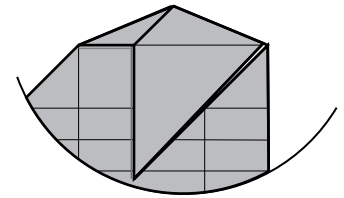

15. Return step 13

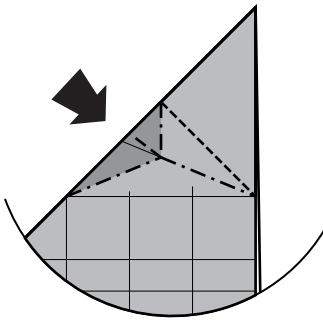

16. Push paper in

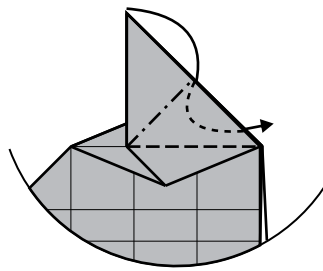

17. Inside reverse fold

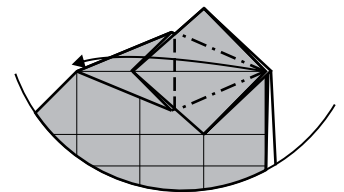

18. Petal fold

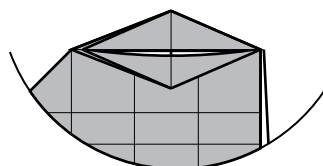

19. Return step 10

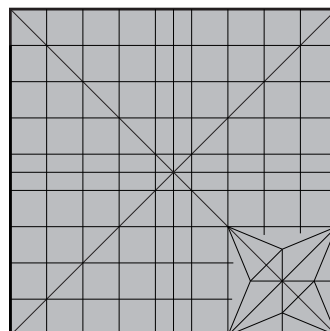

20. Turn paper over

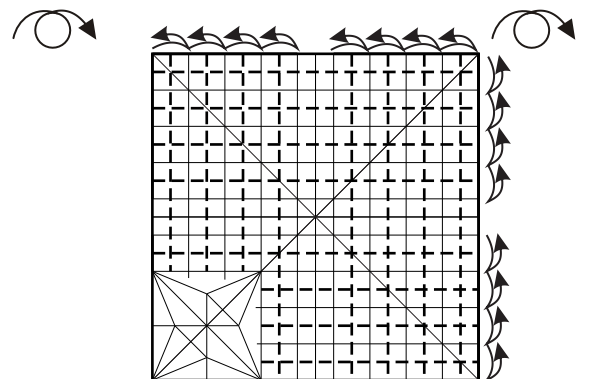

21. Valley fold and unfold



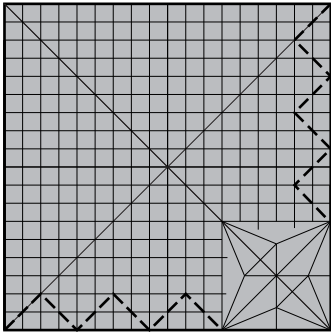

22. Crease as shown

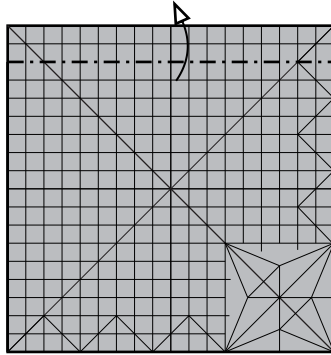

23. Fold paper backwards

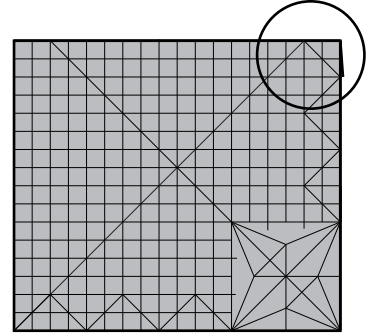

24. Magnified

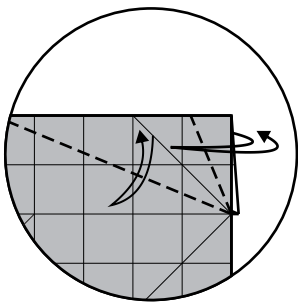

25. Fold and unfold

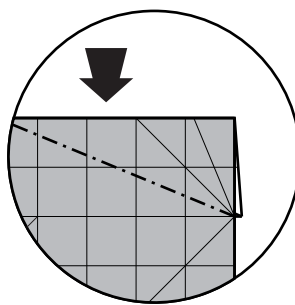

26. Push paper inside

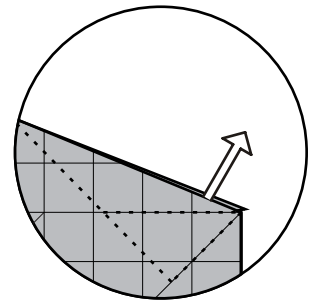

27. Pull out

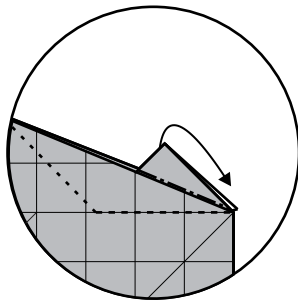

28. Mountain fold

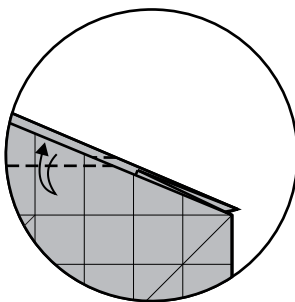

29. Fold and unfold

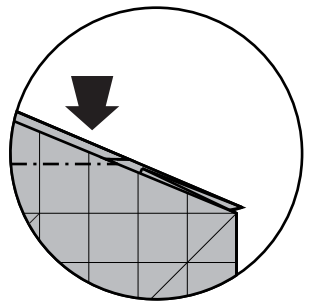

30. Open sink

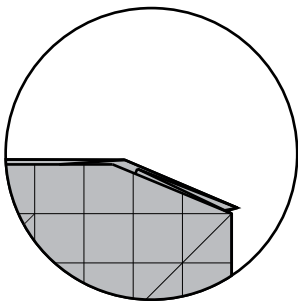

31. Open all

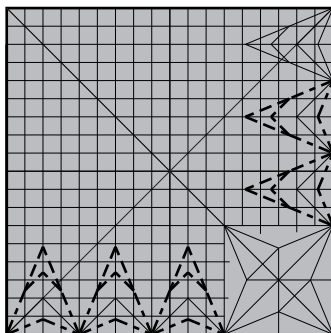

32. Repeat step 23-31 as shown

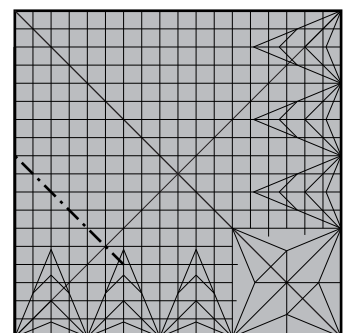

33. Mountain fold and unfold



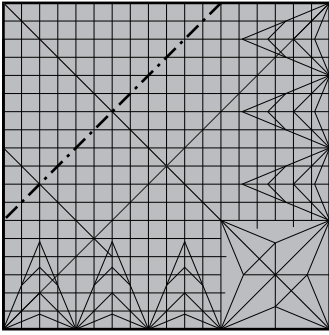

34. Mountain fold and unfold

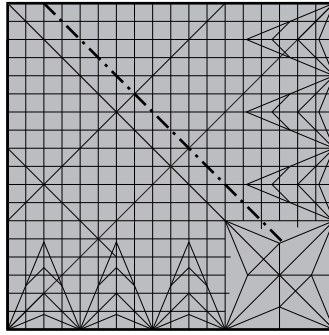

35. Mountain fold and unfold

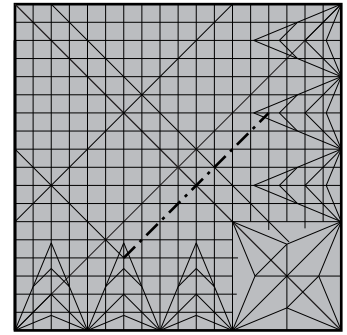

36. Mountain fold and unfold

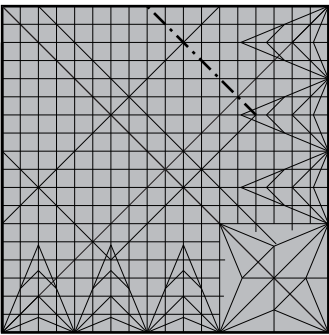

37. Mountain fold and unfold

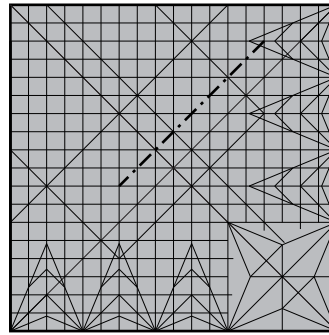

38. Mountain fold and unfold

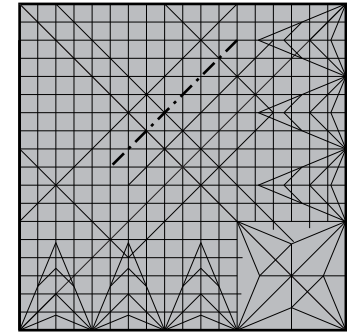

39. Mountain fold and unfold

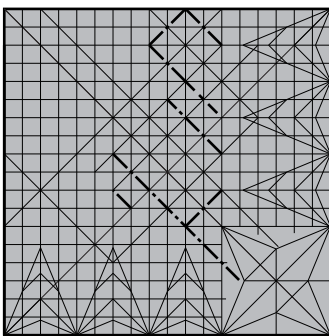

40. Fold and unfold

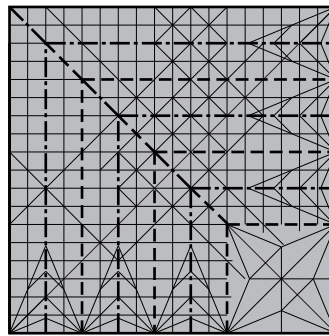

41. Collapse paper as shown

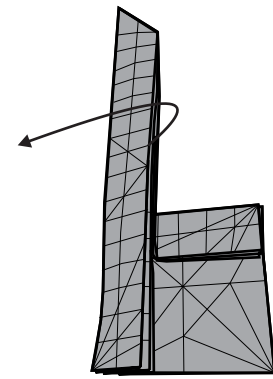

42. Fold all layers turn left

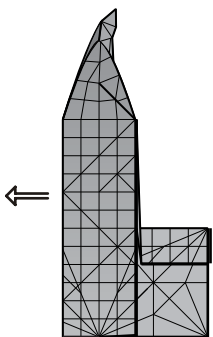

43. Pull one right layer out

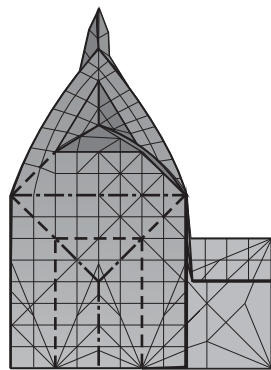

44. Collapse as shown

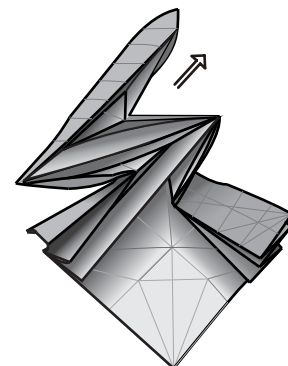

45. Pull one layer out



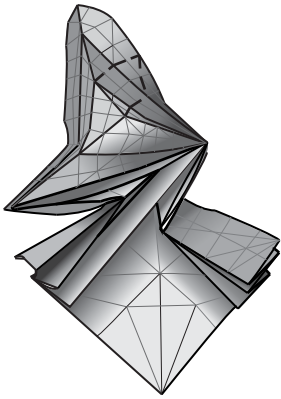

46. Fold as crease shown

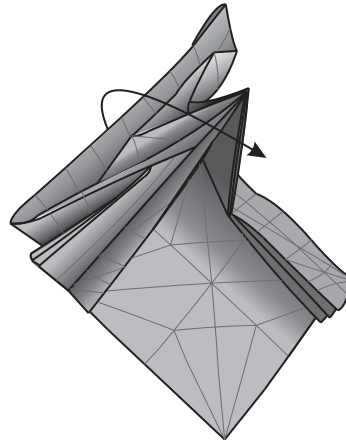
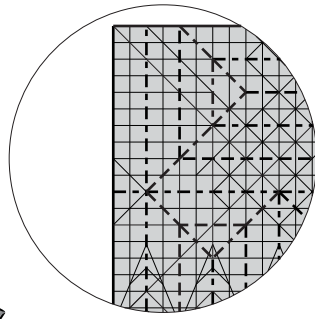

47. Collapse

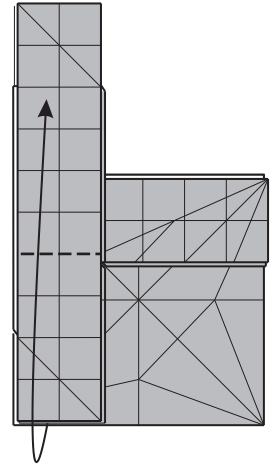

48. Fold forwards

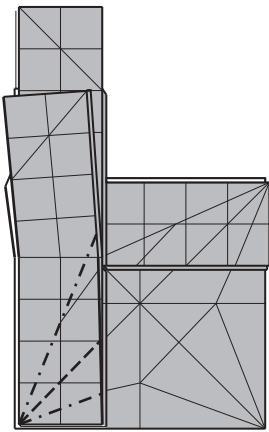

49. Repeat 26-28

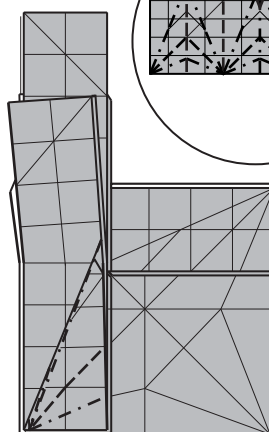

50. Repeat step 49 for rest

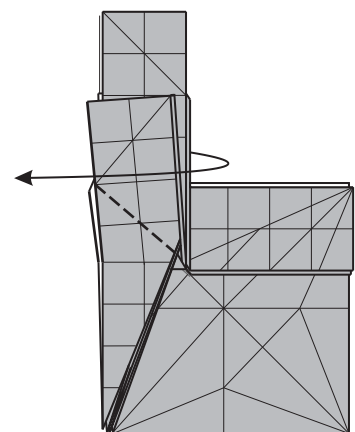
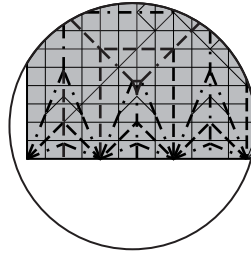

51. Fold turn left

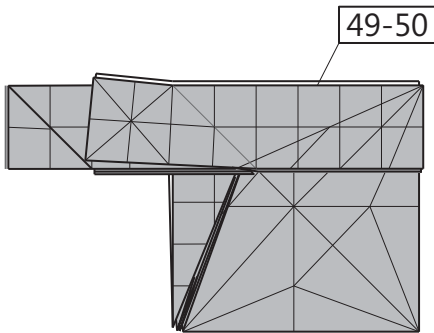

52. Repeat step 49-50

49-50

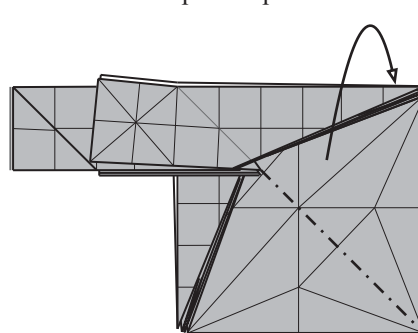

53. Fold backwards

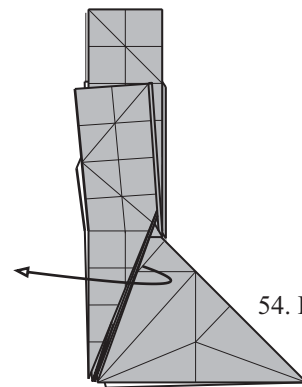

54. Fold turn left

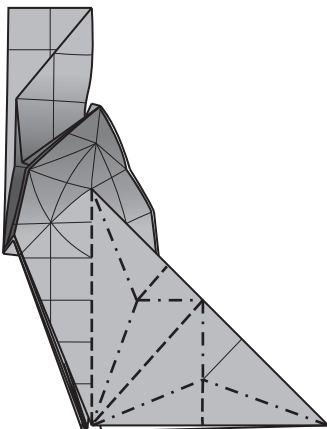

55. Fold bird base

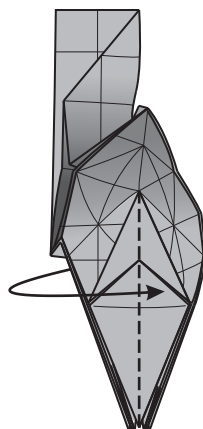

56. Fold back to right

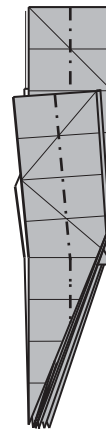

57. Open sink as shown

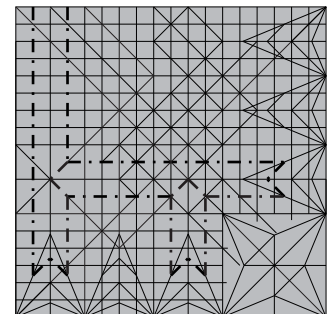

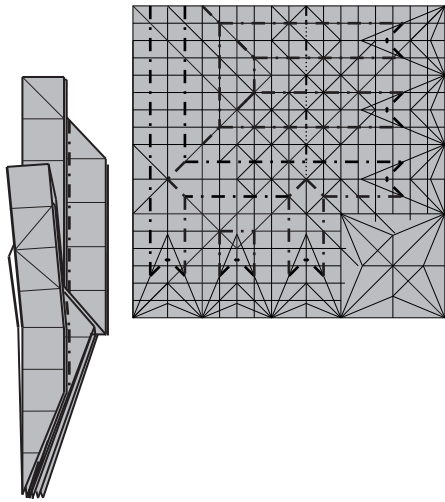

58. Open sink again

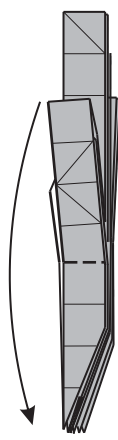

59. Valley fold

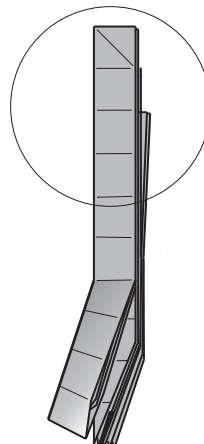

60. Magnified

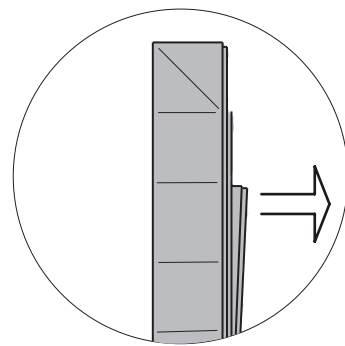

61. Pull out one layer

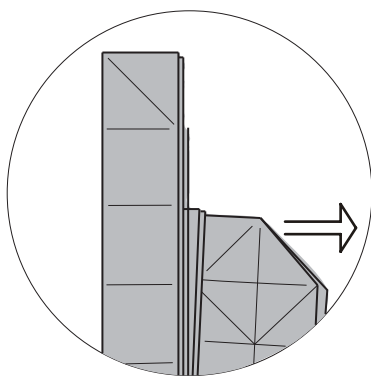

62. Pull out one layer

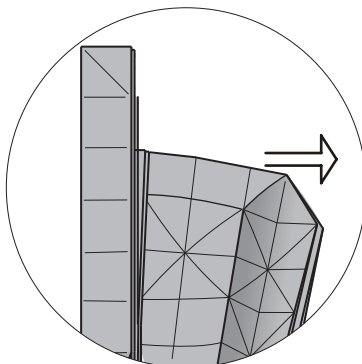

63. Pull out one layer

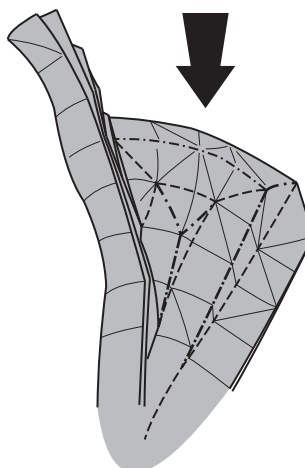

64. push paper down

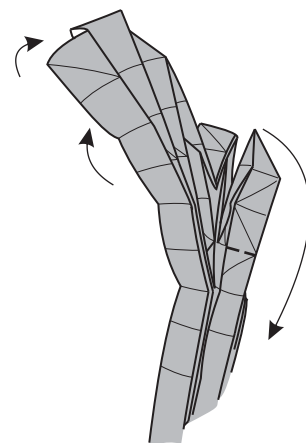

65. Pull right layer down

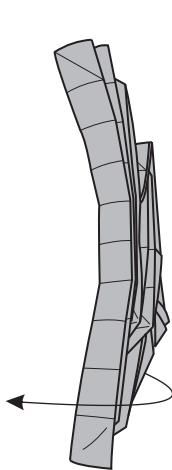

66. Turn left at the middle

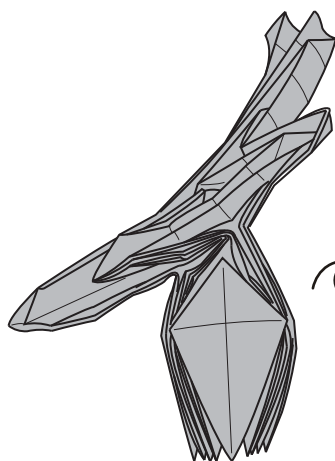

67. Turn over

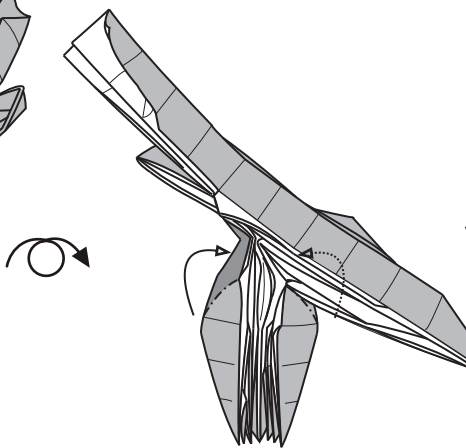

68. Mountain fold for both side

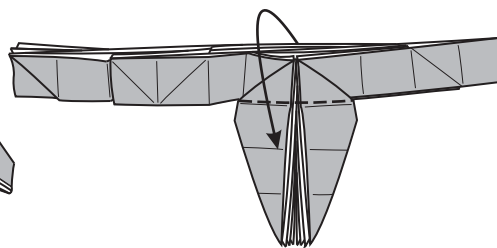

69. Valley fold

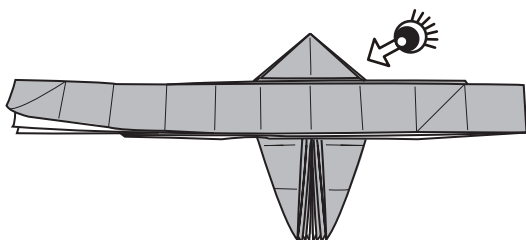

70. Change view

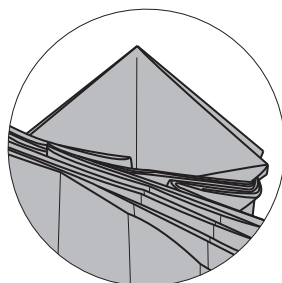

71. The corner like this. Return view

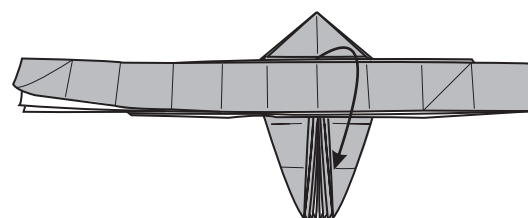

72. Pull down



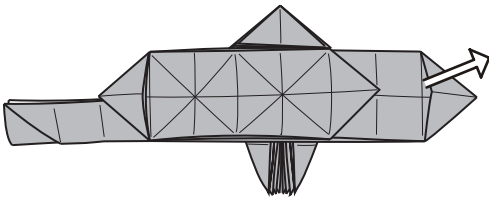

73. Pull out

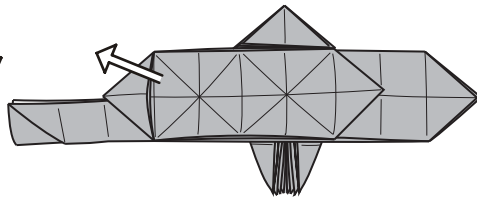

74. Repeat pull out

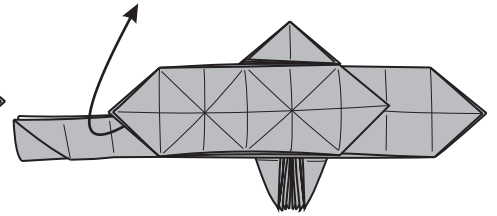

75. Elevate

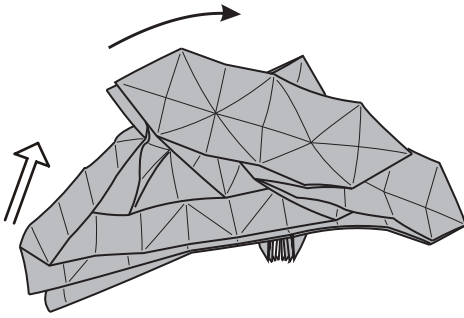

76. Elevate higher

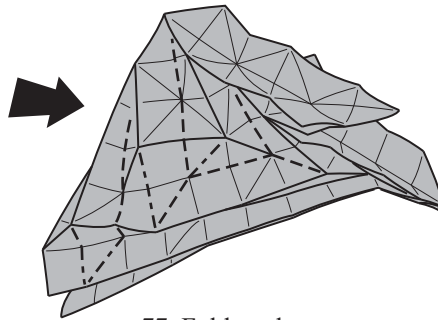

77. Fold as shown

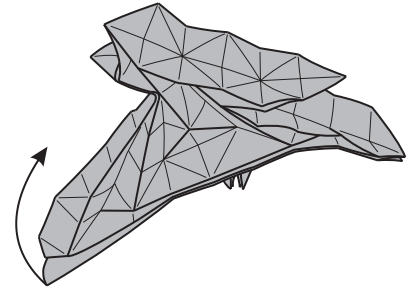

78. Turn fore

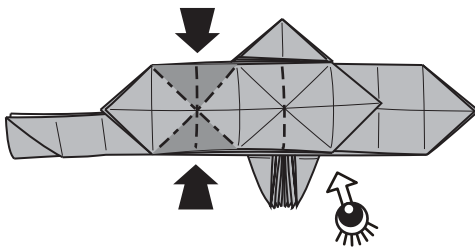

79. Open sink. Change view

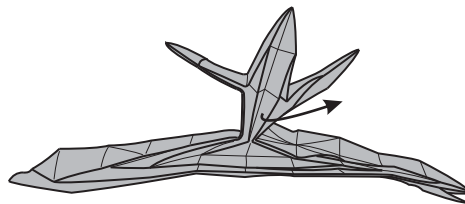

80. Turn middle right

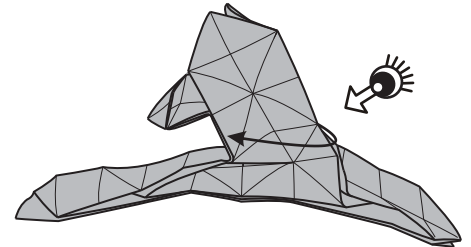

81. Turn one layer left

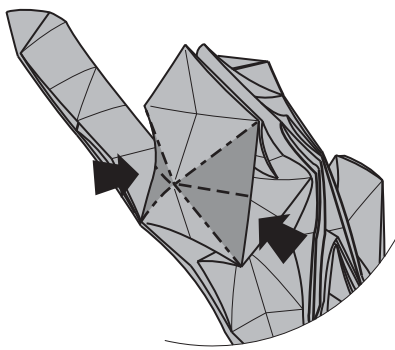

82. Pull top out

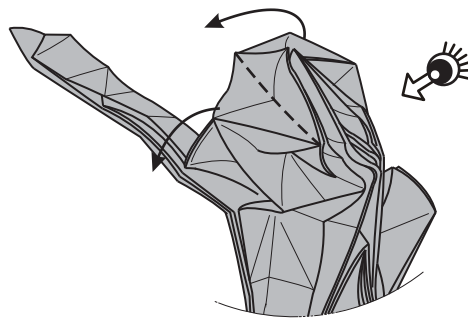

83.

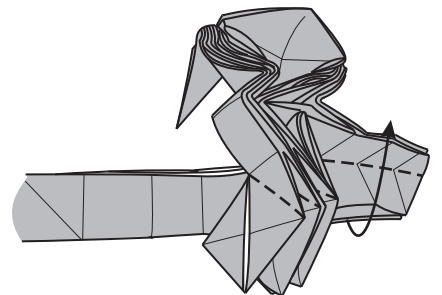

84. Valley fold

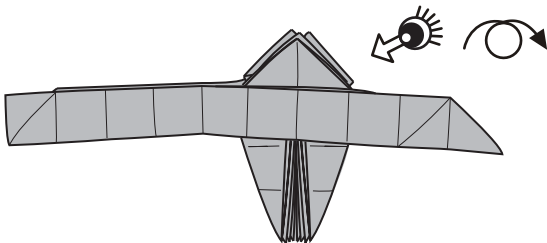

85. Turn over, change view

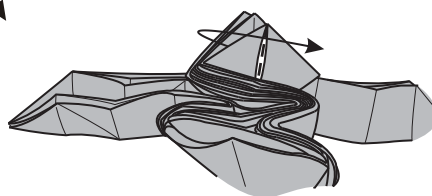

86. Turn one layer right

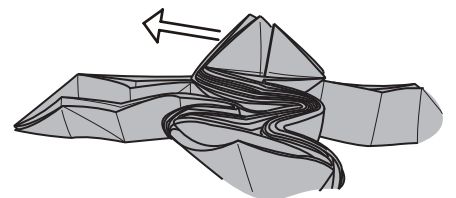

87. Pull second layer out



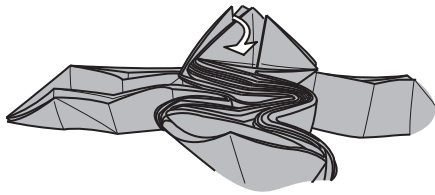

88. Drag it on top

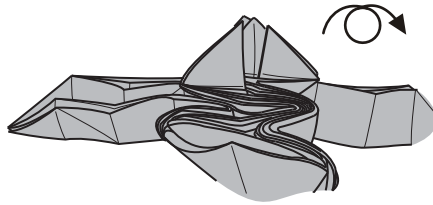

89. Turn over

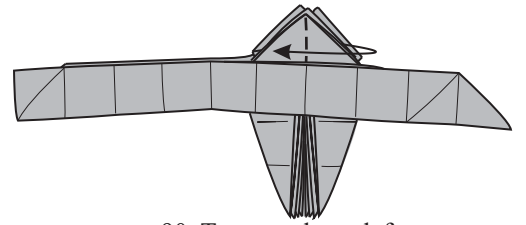

90. Turn one layer left

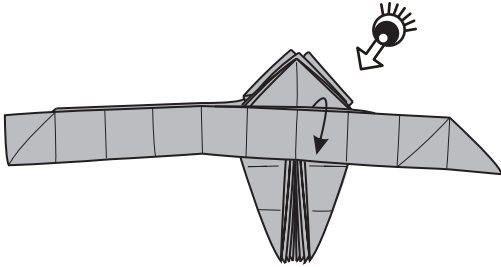

91.

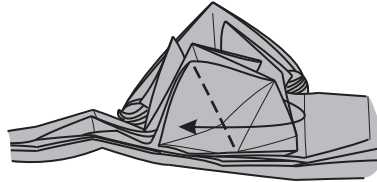

92. Turn one layer left

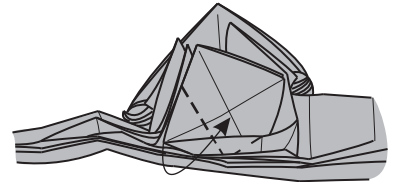

93. Valley fold

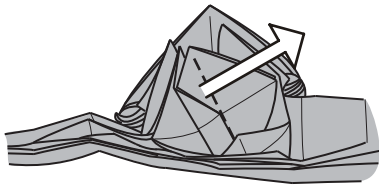

94. Pull outl

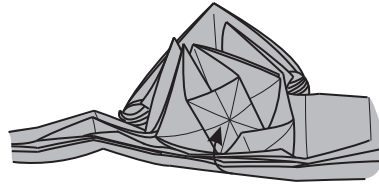

95. Valley fold

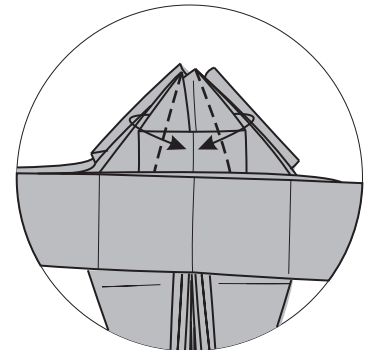

96. Valley fold

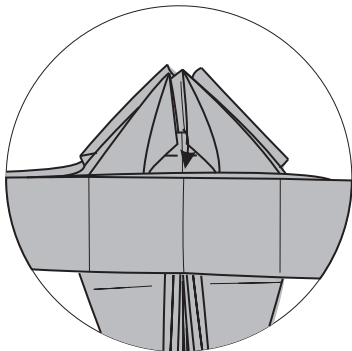

97. Valley fold

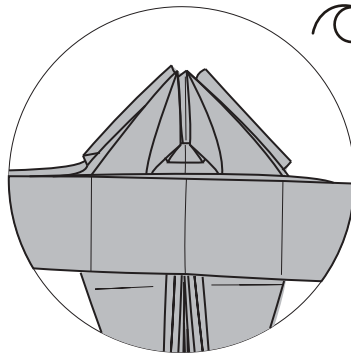

98. Turn over

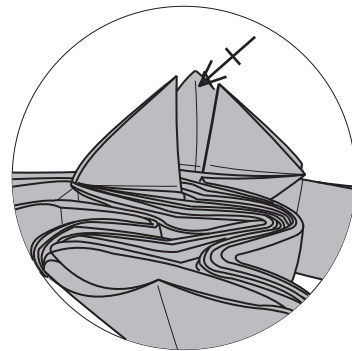

99. Repeat 93 - 98

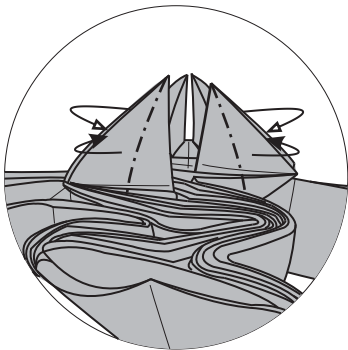

100. Fold backwards

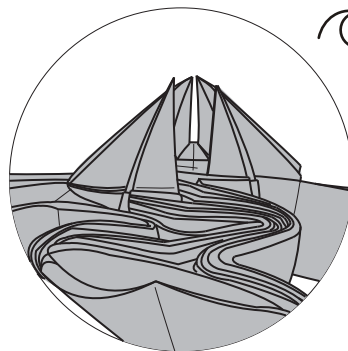

101. Turn over

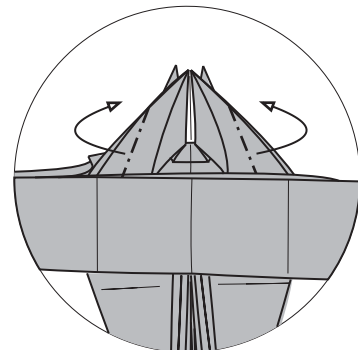

102. Fold backwards



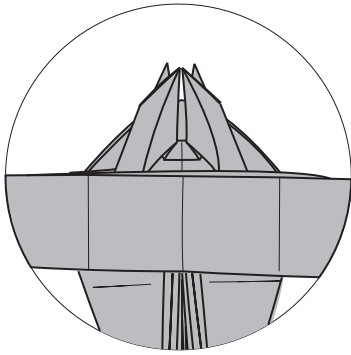

103. Zoom out

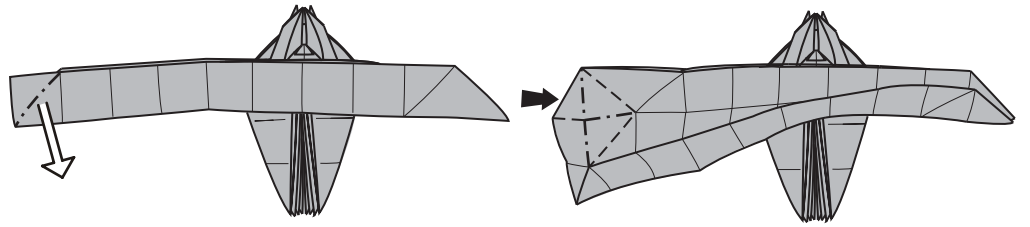

104. Pull

105. Fold as shown

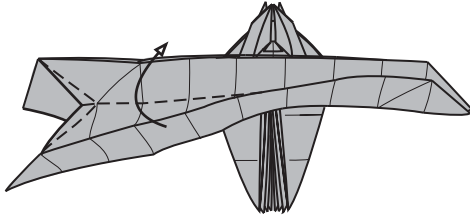

106. Valley fold

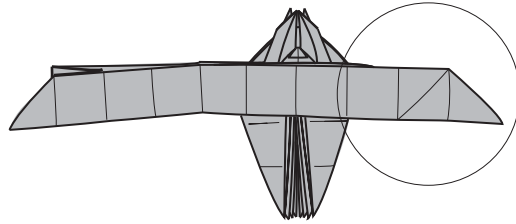

107. Zoom in

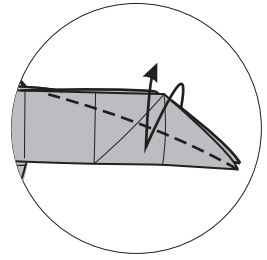

108. Fold and unfold

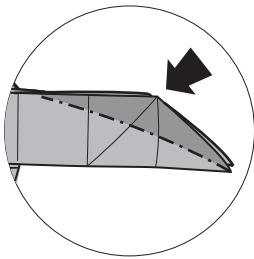

109. Open sink

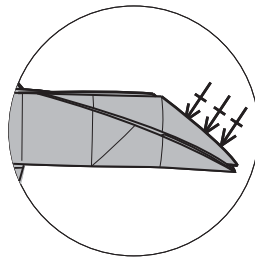

110. Repeat 108-109

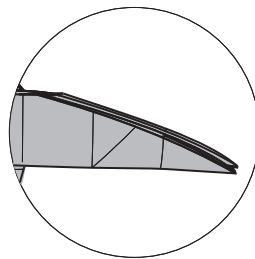

111. Zoom out

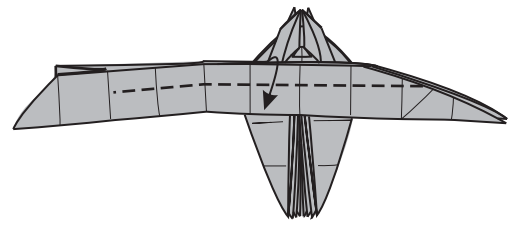

112. Fold one layer down

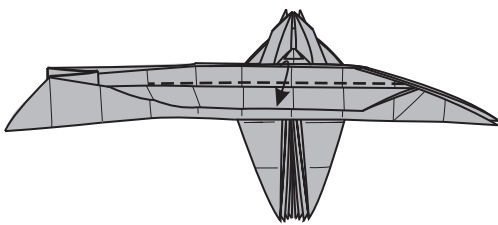

113. Fold again

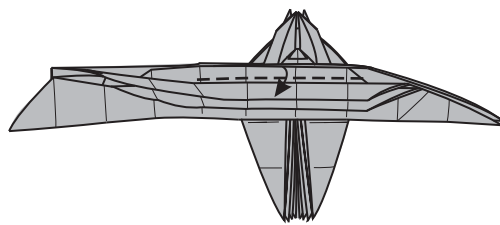

114. Fold again

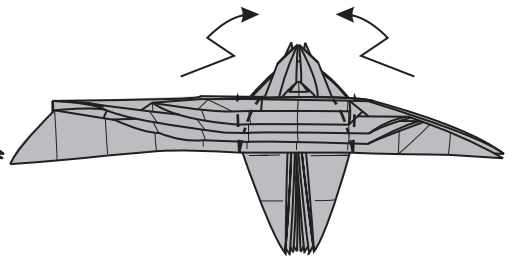

115.

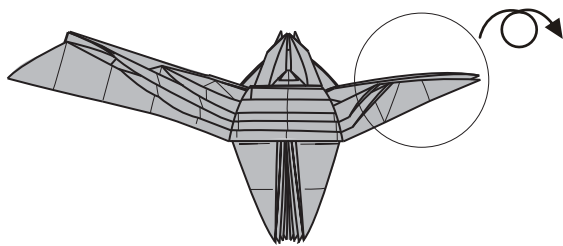

116. Zoom in

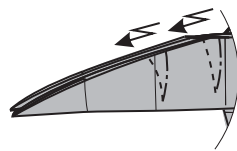

117.

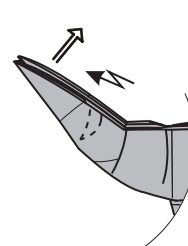

118.

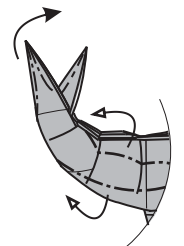

119. Shaping

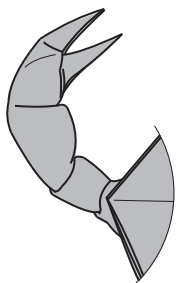

120. Finish

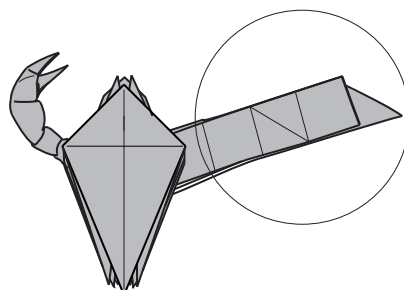

121. Zoom in

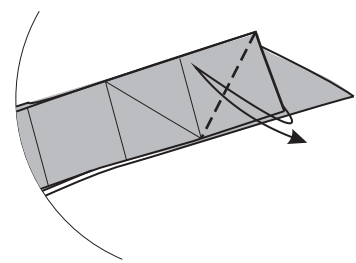

122. Fold and unfold



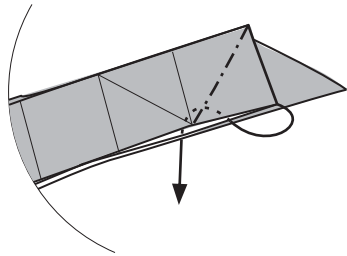

123. Reverse inside

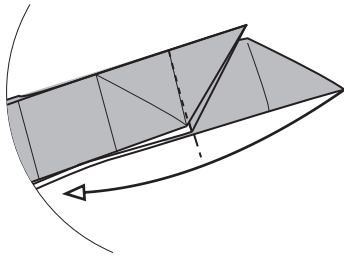

124. Fold back

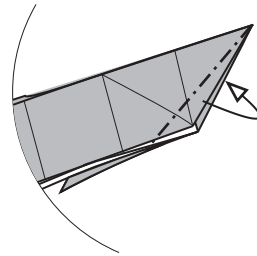

125.

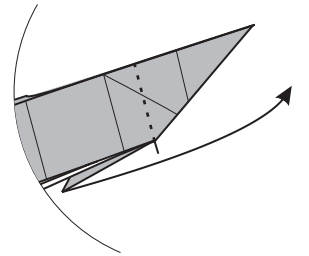

126.

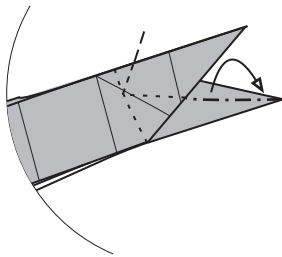

127.

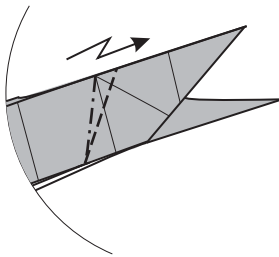

128

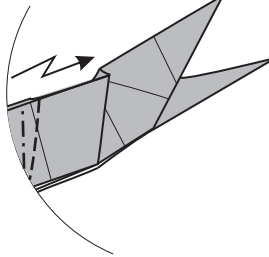

129

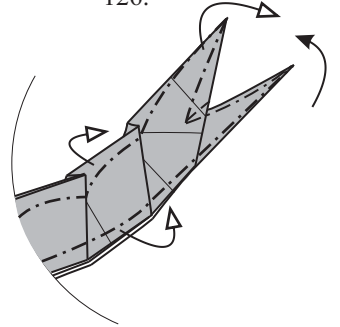

130. Shaping

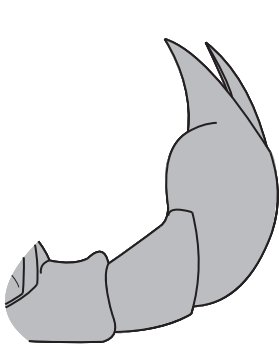

131. Finish

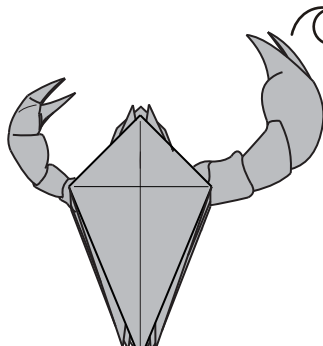

132. Turn over

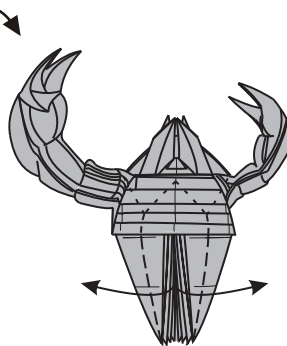

133. Valley fold for all eights leg

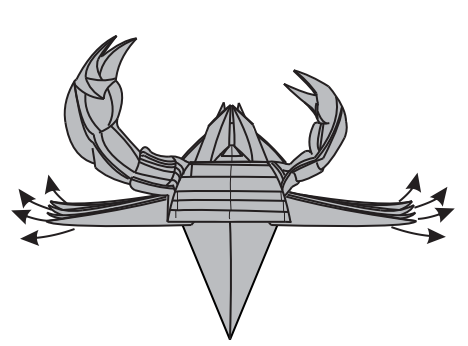

134.

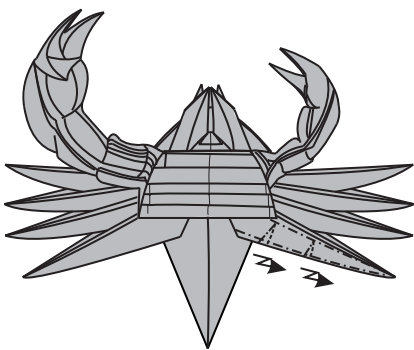

135.

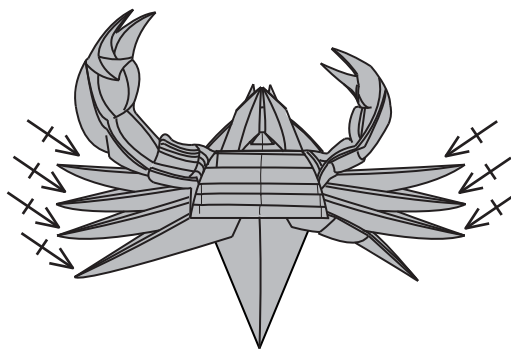

136. Repeat for remain legs

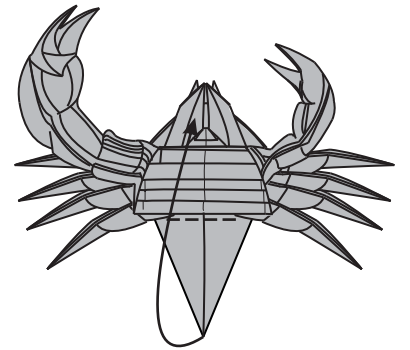

137.

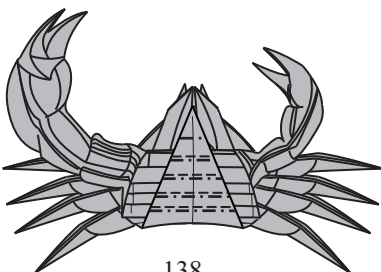

138.



139. Magnified

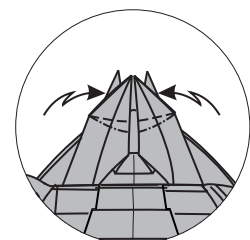

140.



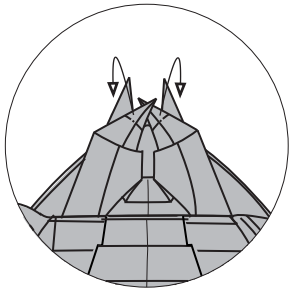

141.

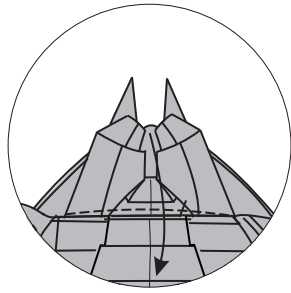

142. Turn down

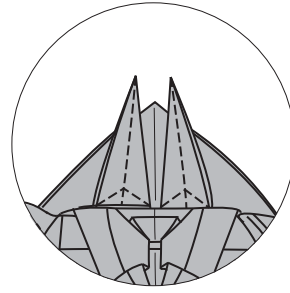

143.

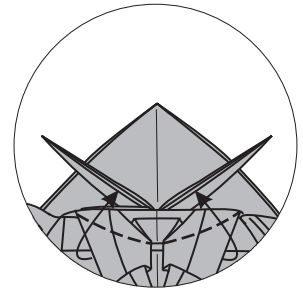

144.

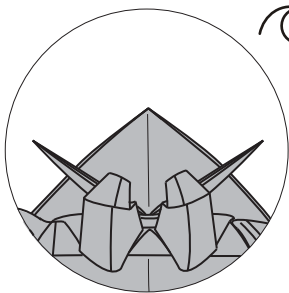

145. Turn over

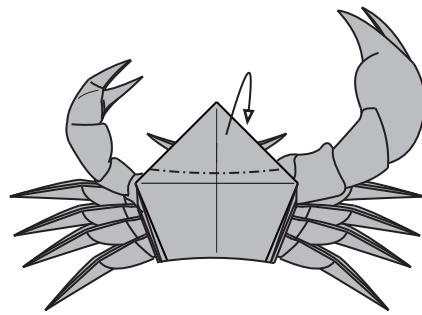

146. Fold forwards

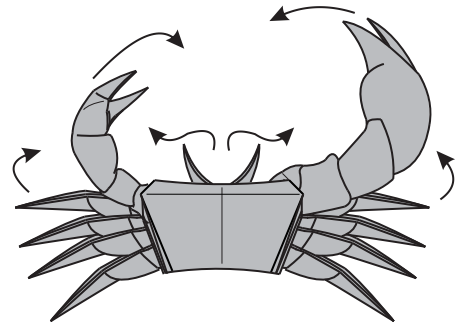

147. Shaping

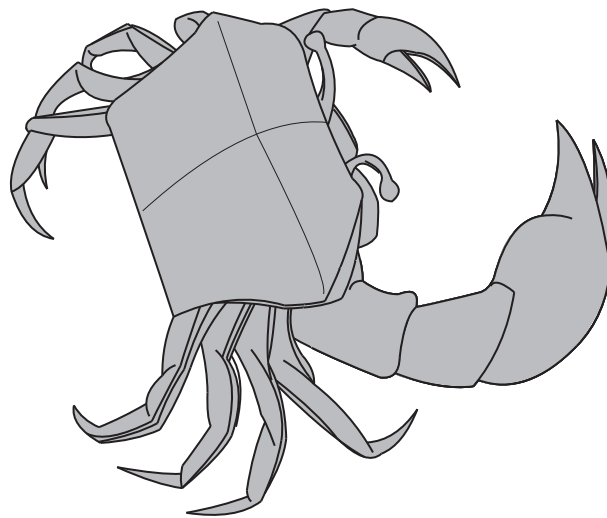

148. Finished

