

~Pac-Manbou (Sunfish)~

Designed & Drew the diagram by Origami_zuki

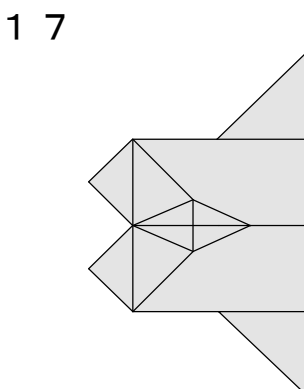

You're done!
But wait, there's a next level... Good luck!

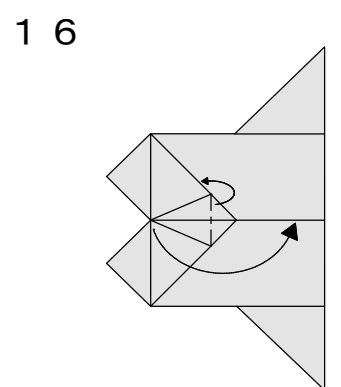
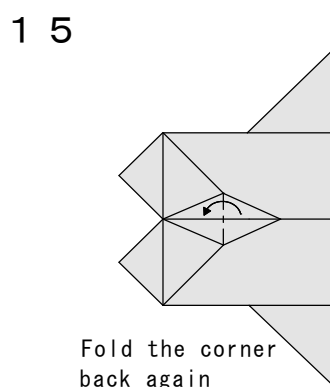
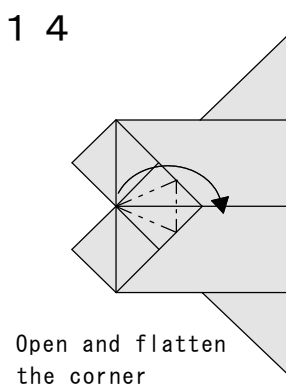
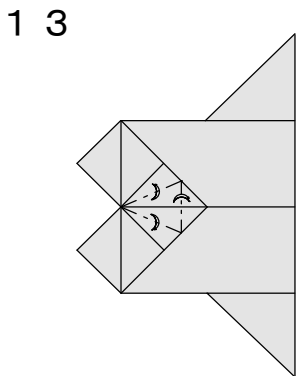
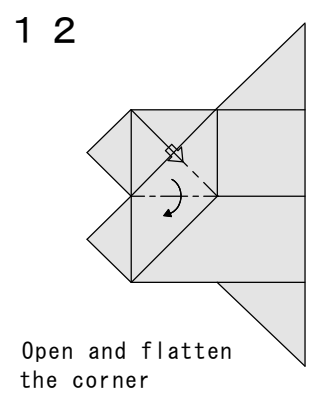
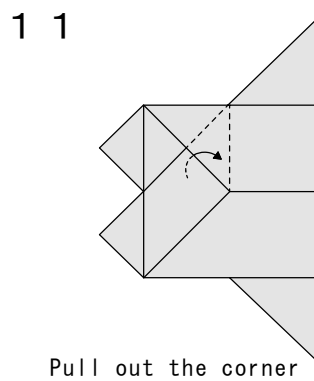
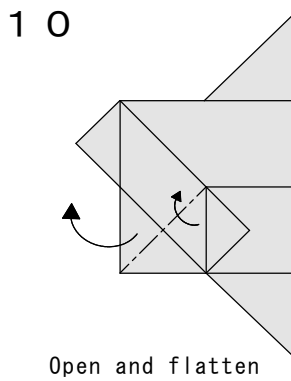
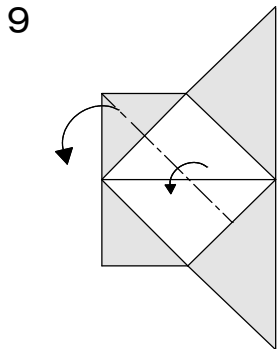
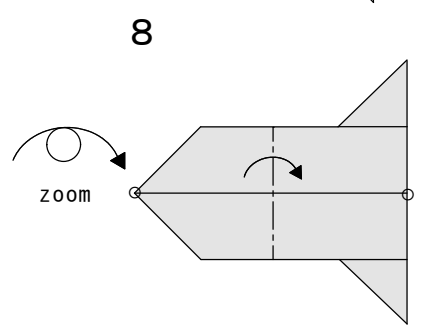
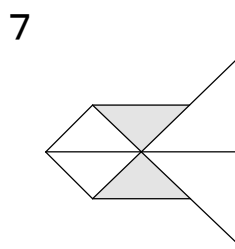
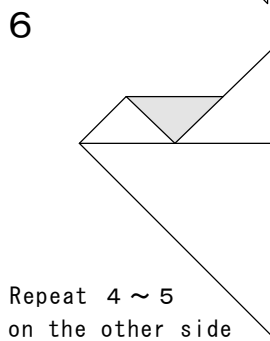
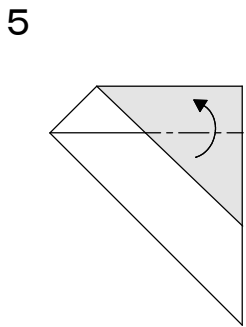
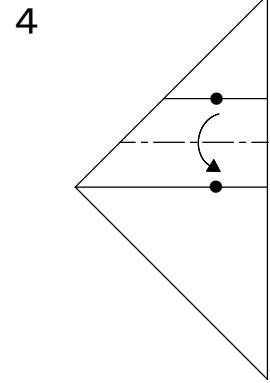
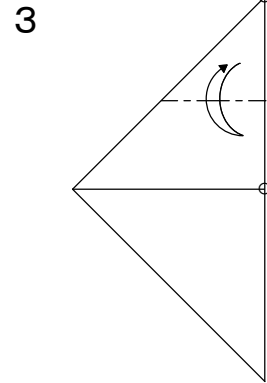
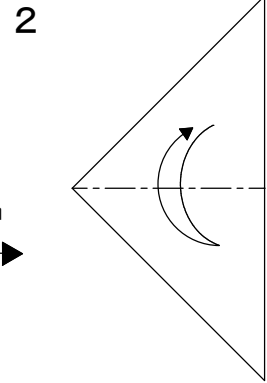
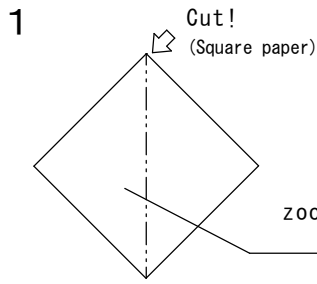
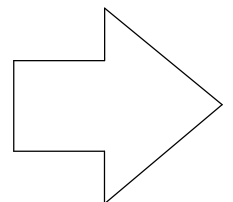

Next Page

~Transform 1 : Owl~

1

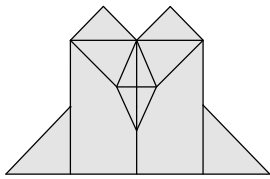

From "Pac-Manbou"

2

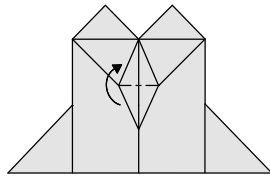

3

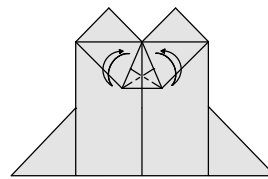

4

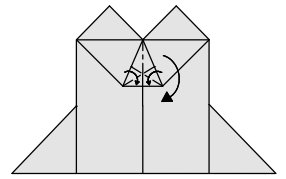

Fold along the creases made in step 3

5

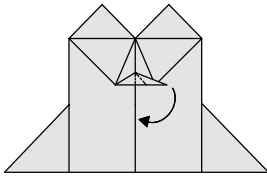

Open and flatten the creases made in step 3

6

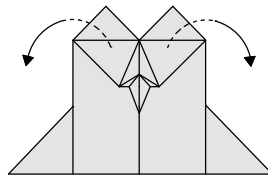

Slightly open and shape

7

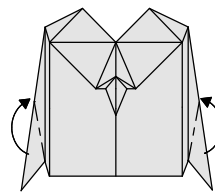

Fold the corner and make wings

8

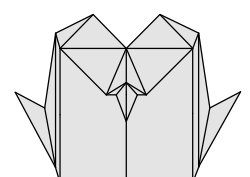

You're done!

~Transform 2 : Bat~

1

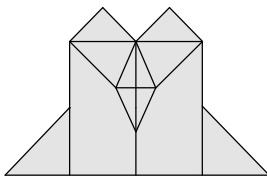

From "Pac-Manbou"

2

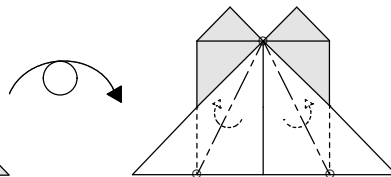

Fold hidden side

3

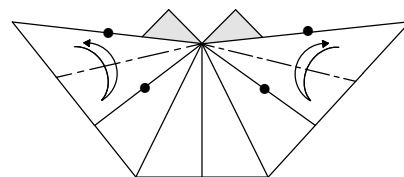

4

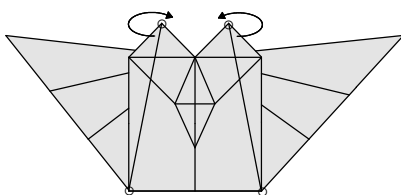

5

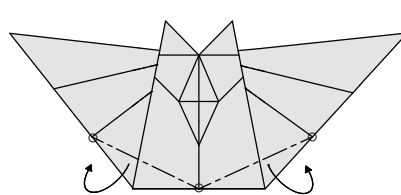

6

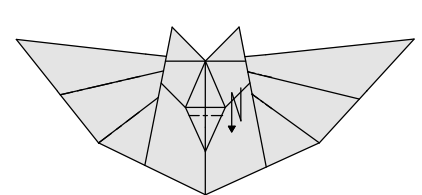

Pleat fold a little

7

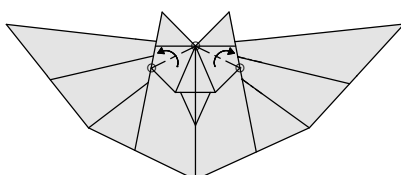

Fold slightly and shape

8

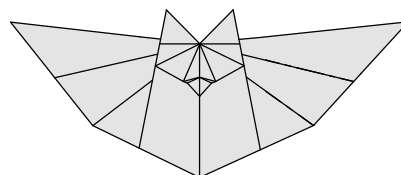

You're done!



@ORIGAMI_ZUKI

Thank you for folding my designs!

For finished examples, check out my Instagram.

