

1 lato rosso

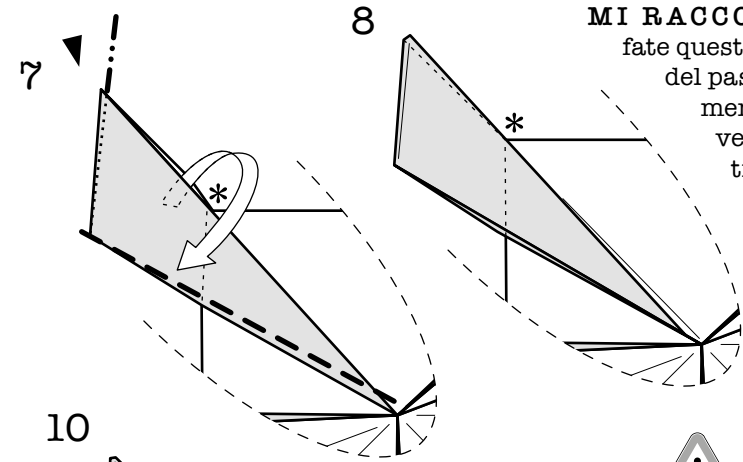

MI RACCOMANDO (o:
fate questa piccola piega
del passaggio 7 altri-
menti, alla fine, si
vedrà un antipa-
tico bordo bian-
co causato dai
molti strati
di carta.

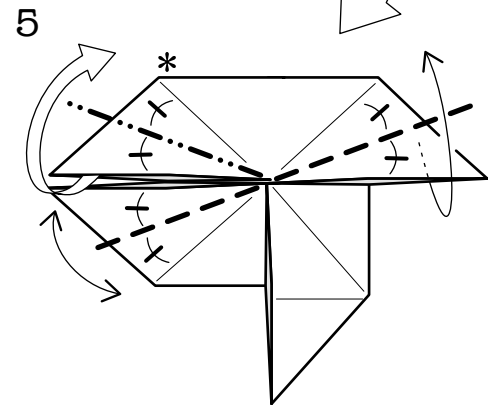
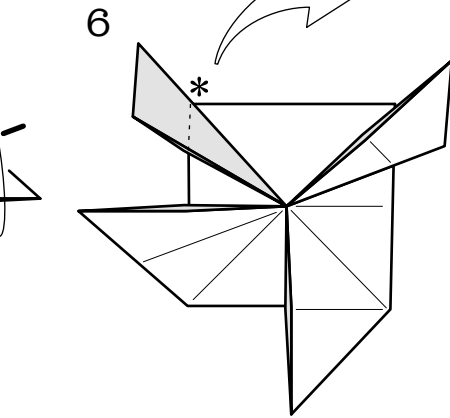
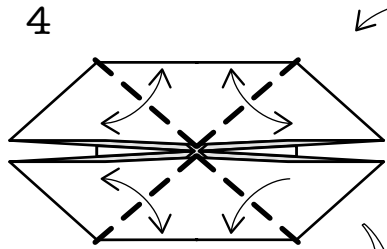
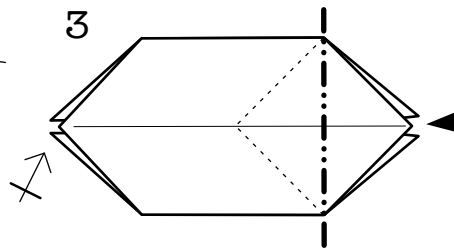
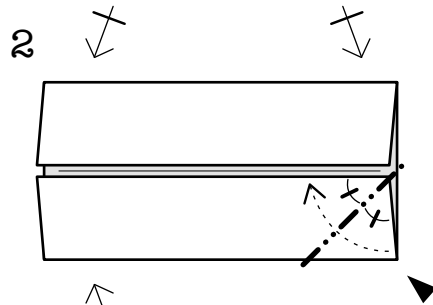
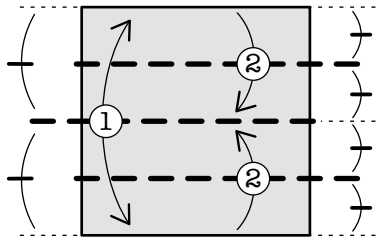