

Encyclia cordigera

©Cekouat León, 2015

Facebook: Cekouat Origami Works

Paper: Sandwich, thin paper, 12 x 12 for getting a real size flower.

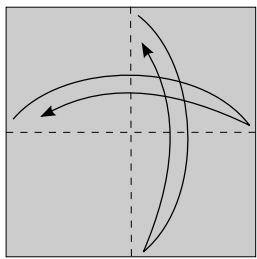

1.

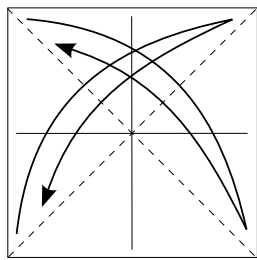

2.

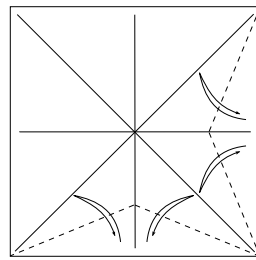

3.

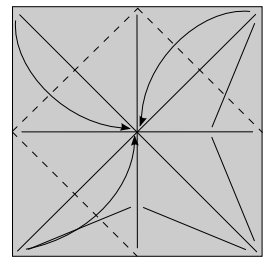

4.

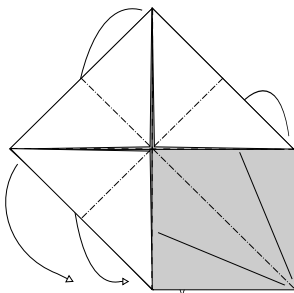

5.

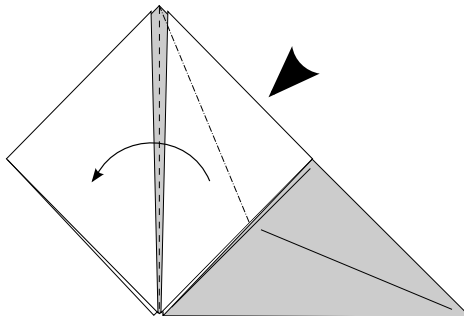

6.

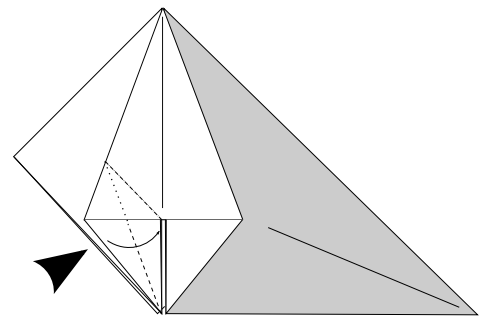

7.

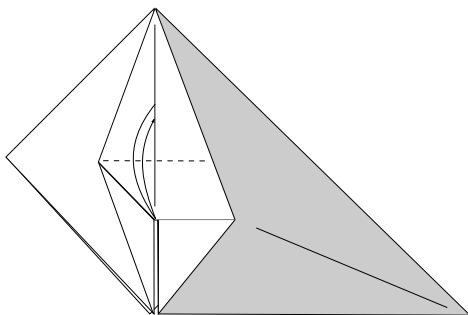

8.

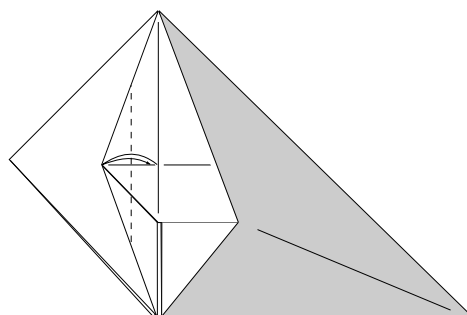

9.

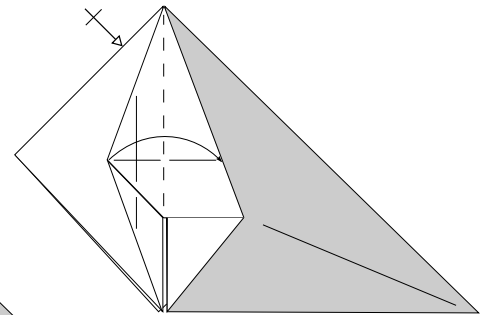

10. Repetir pasos 6-10 en la parte de atrás.

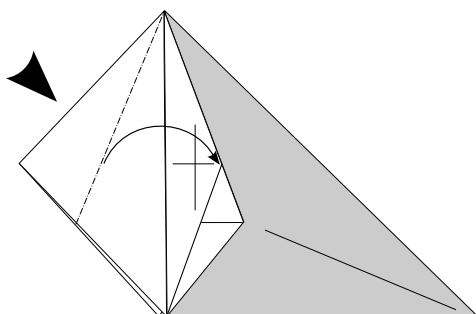

11.

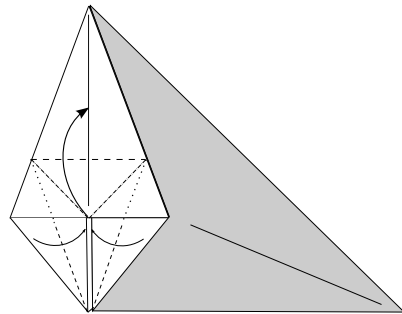

12.

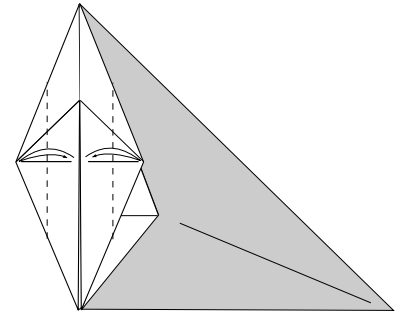

13.

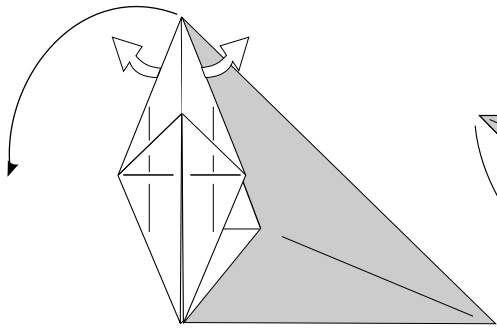

14. Sacar el papel

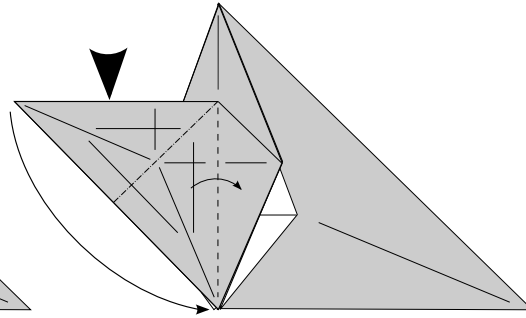

15.

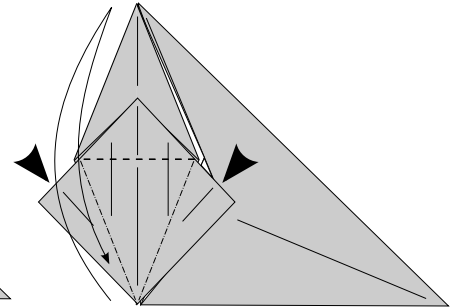

16.

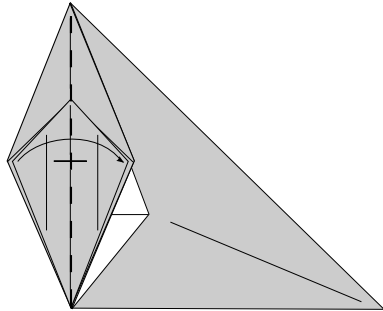

17.

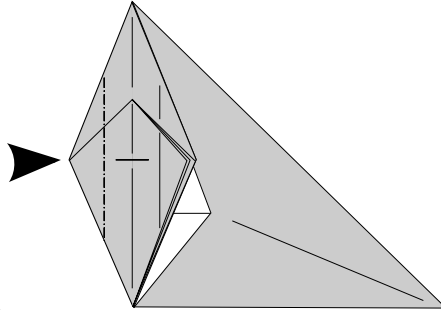

18. Hundido abierto.

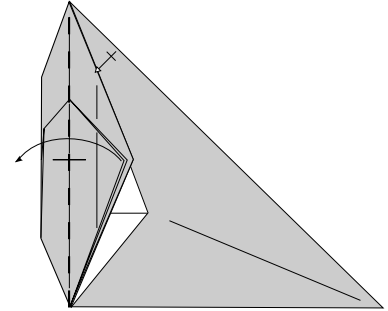

19. Repetir pasos 18-19 del lado derecho.

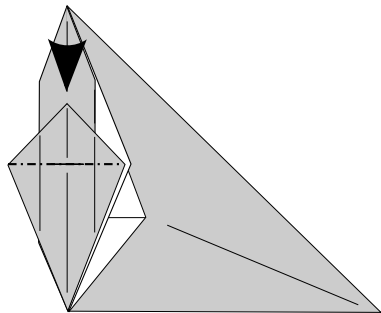

20. Hundido cerrado.

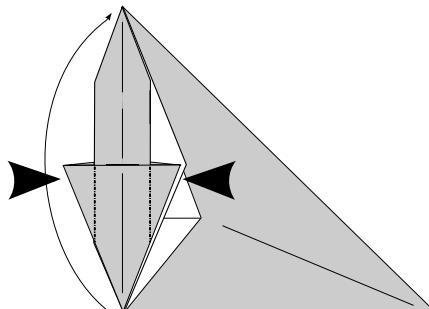

21. Hundido mixto.

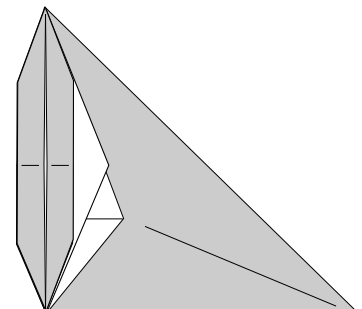

22. Así debe lucir.

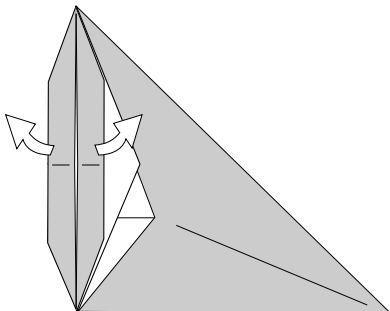

23. Abrir la primera solapa.

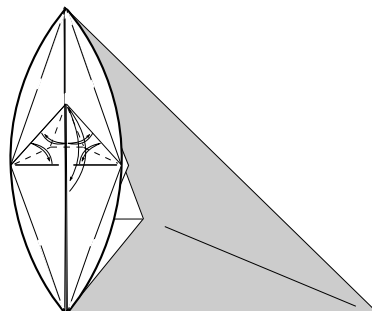

24.

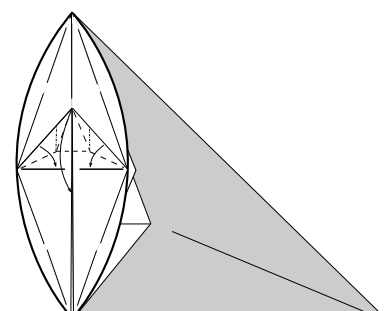

25.

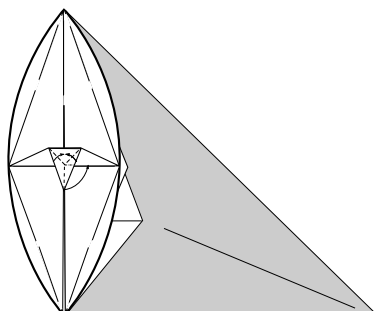

26.

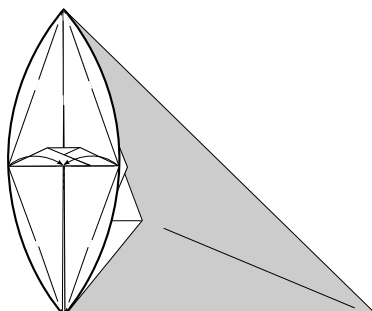

27. Cerrar la solapa.

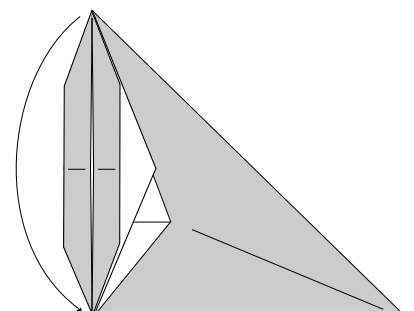

28.

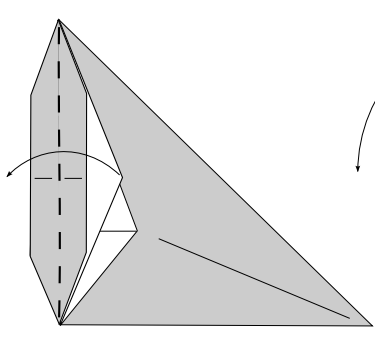

29.

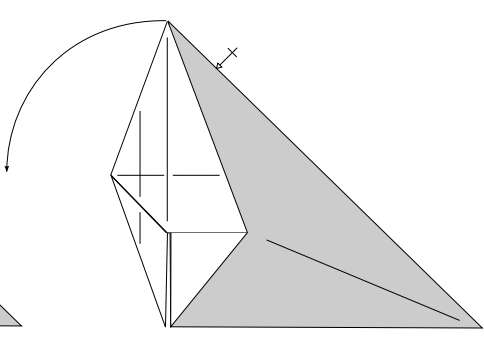

30. Sacar el papel.
Repetir atrás

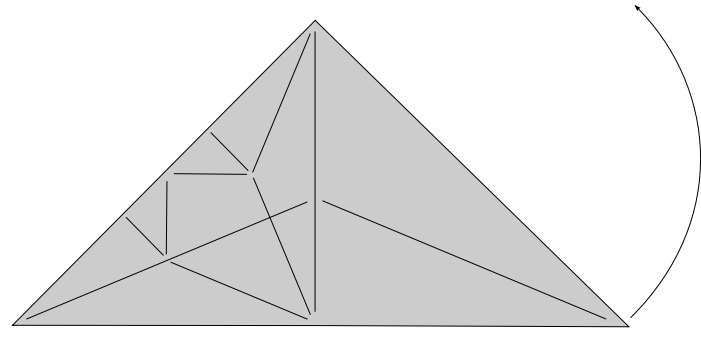

31. Jalar la punta.

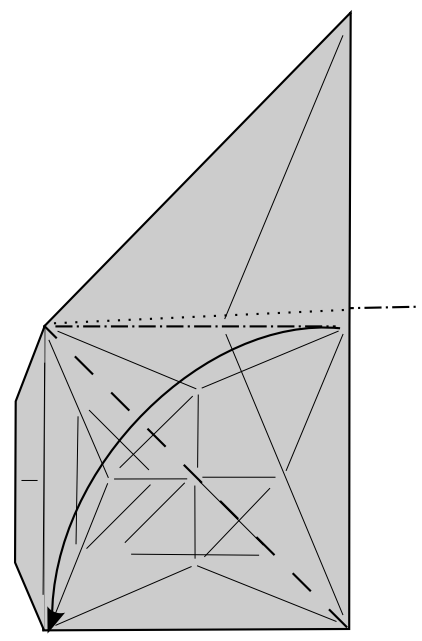

32.

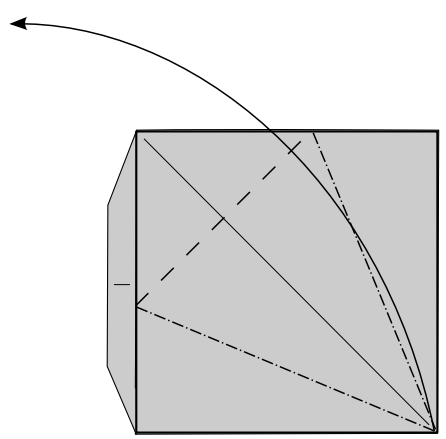

33.

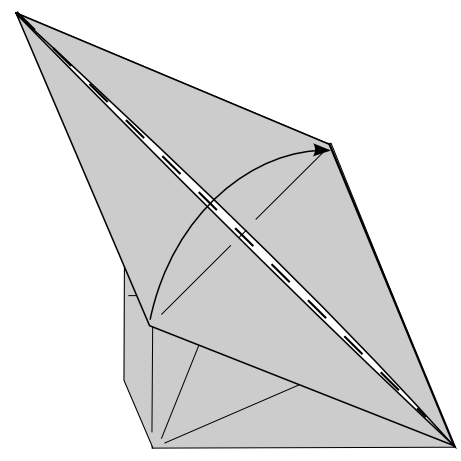

34.

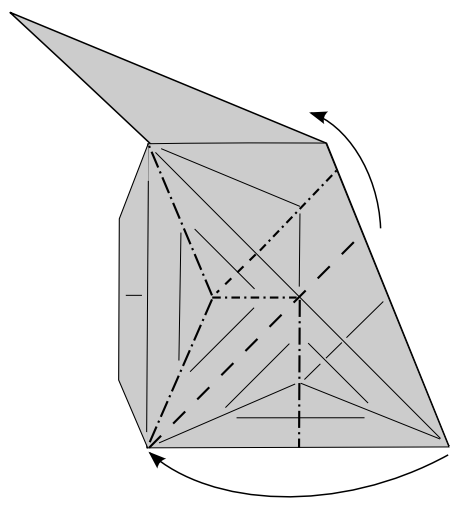

35. Doblar como se indica.

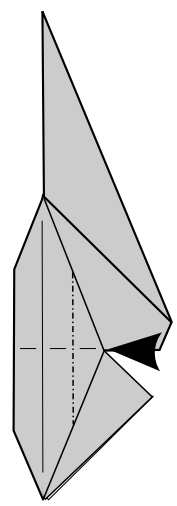

35. Hundido abierto

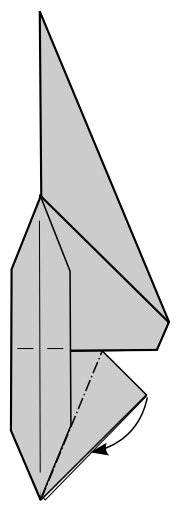

36.

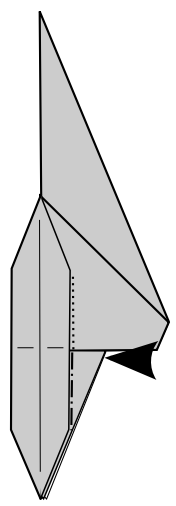

37. Hundido abierto

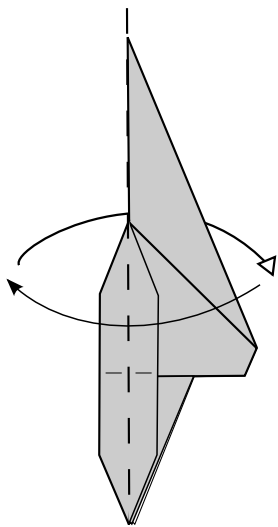

38.

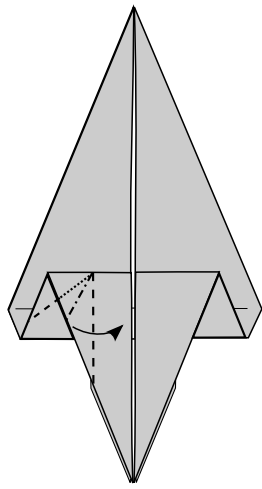

39.

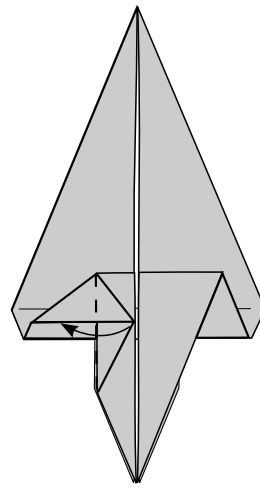

40.

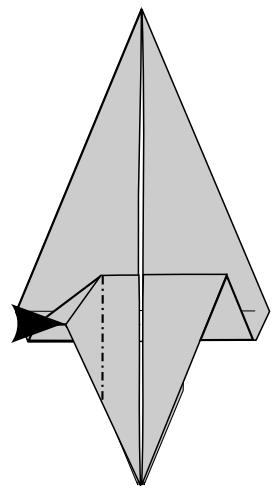

41.

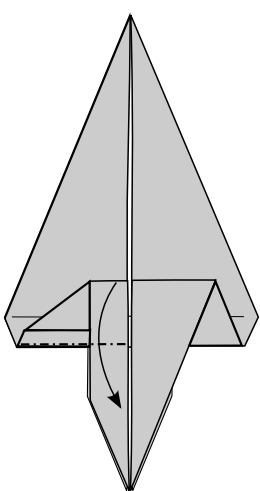

42.

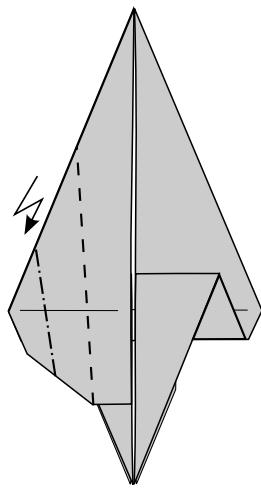

43.

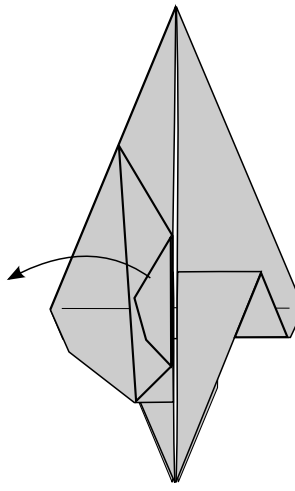

44.

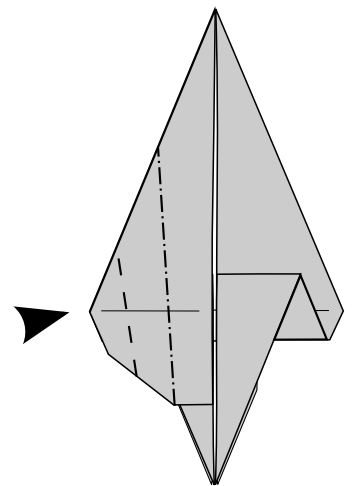

45. Hundido mixto/
mixed sink.

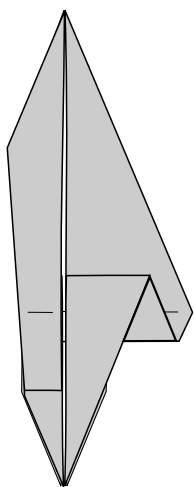

46.

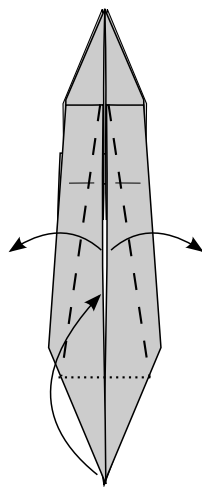
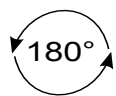

47.

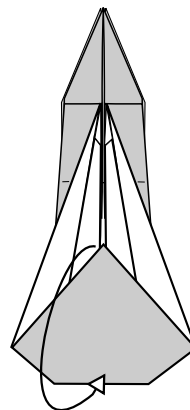

48.

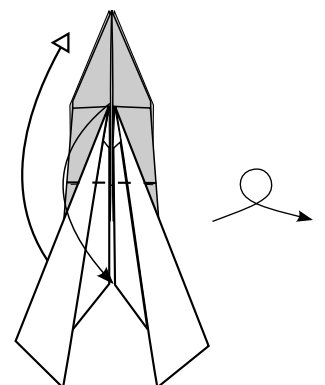

49.

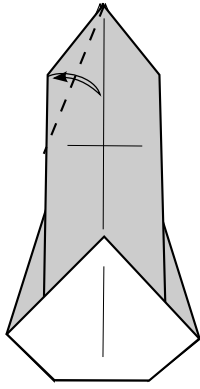

50.

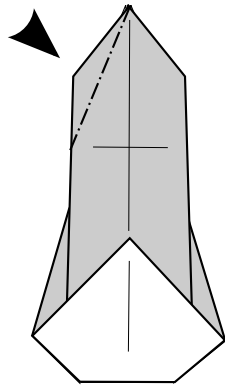

51.

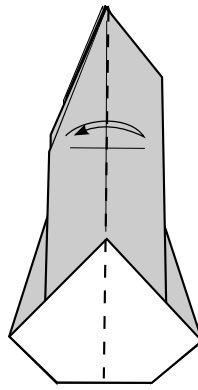

52.

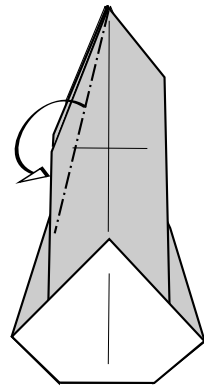

53.

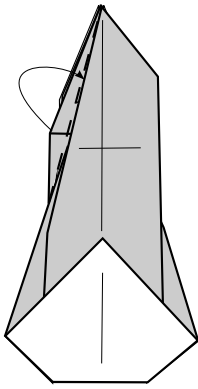

54.

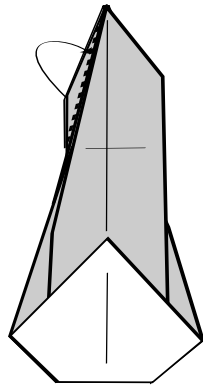

55.

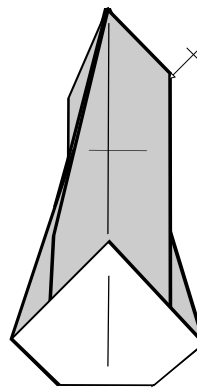

56.

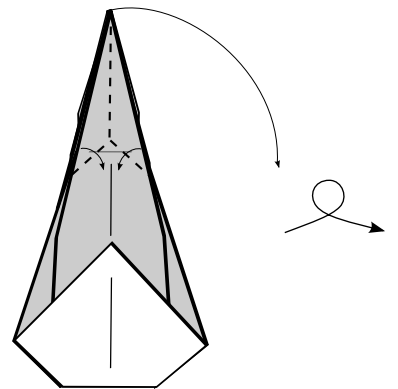

57.

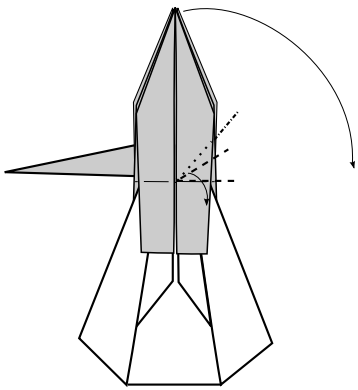

58.

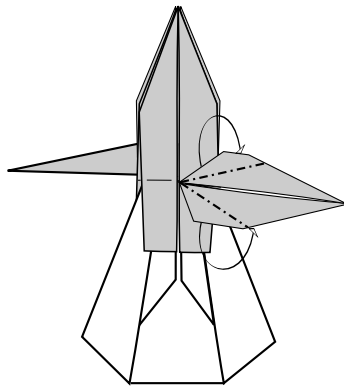

59.

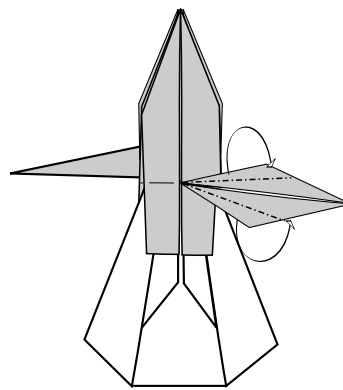

60.

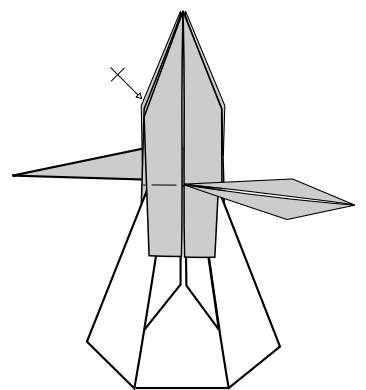

61.

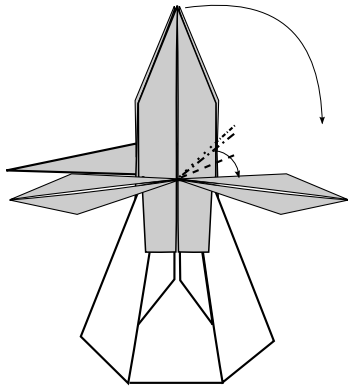

62.

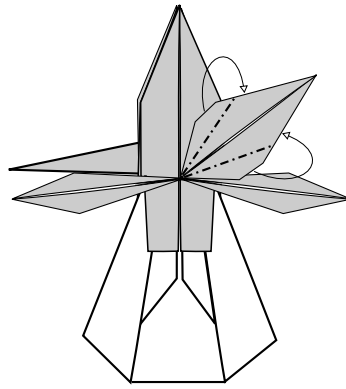

63.

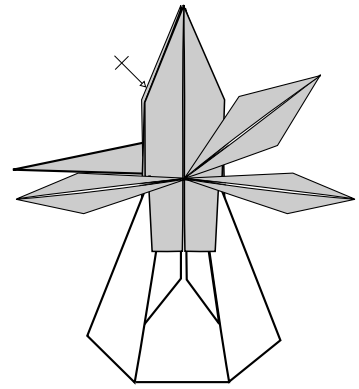

64.

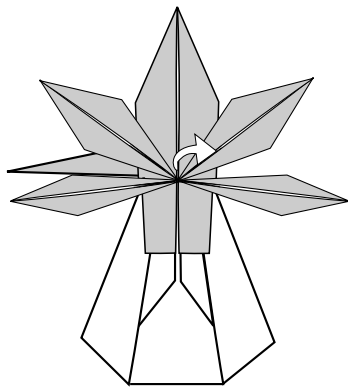

65.

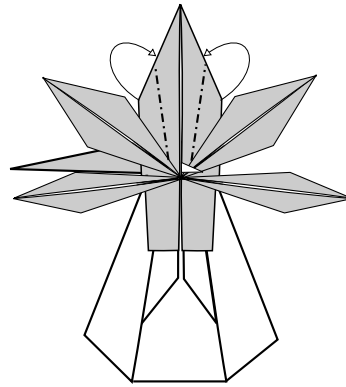

66.

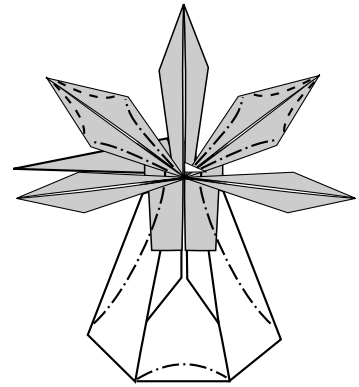

67.

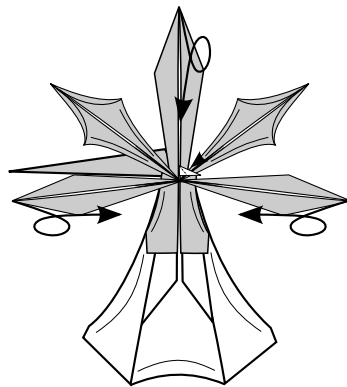

68.

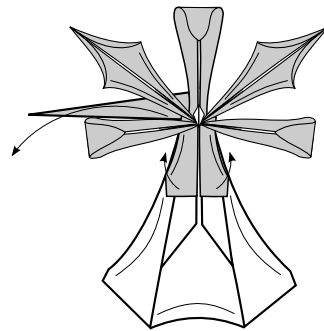

69.

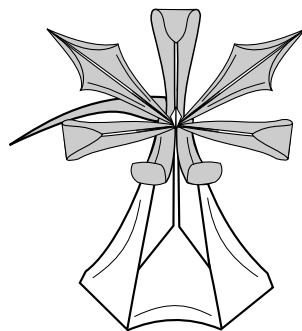

70. Modelo terminado/
Model completed