

HOW TO FOLD THE UNIVERSAL

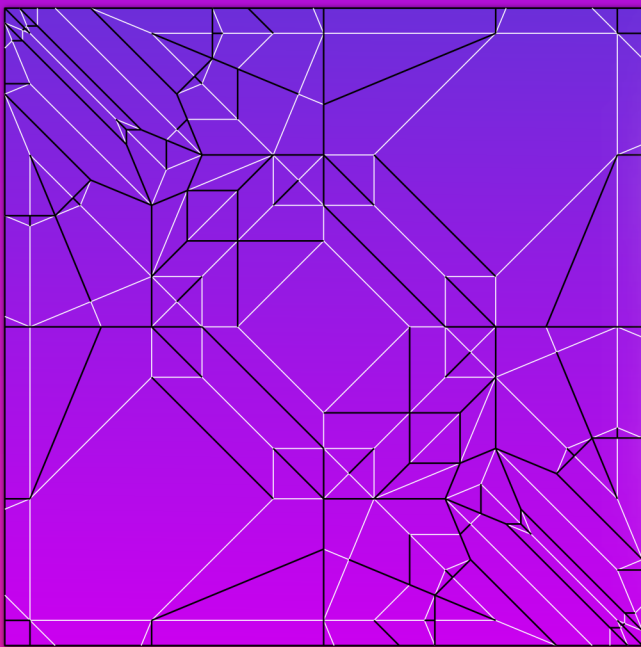

Crease pattern and folded
model shown to scale.

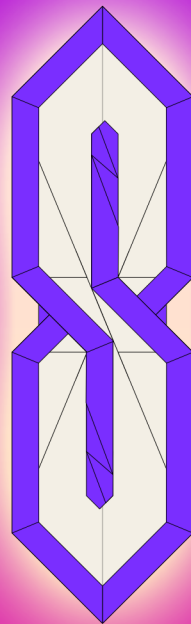

No one knows exactly where it comes from, but we all remember drawing it. Now available in origami! Use up those packets of origami paper you have lying about. Bored in class? at work? Tired of cranes? Fold 1000 of these and be the envy of everyone who didn't fold 1000 of these!

Please do not ask for crease patterns or diagrams. They are right here. Look to the left. There is the crease pattern. Now turn the page. The diagrams begin. Keep turning, there are more pages. There you go. Become familiar with open sinks and the standard origami techniques before attempting this model. You will need them.

Feel free to distribute these diagrams!

SYMBOL

Designed by Brian Chan

 brianchandesigns

- Intended for free distribution -

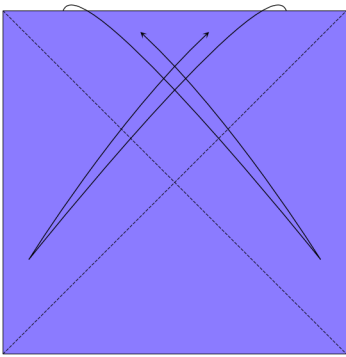

1. Start with the colored side up. Crease along the diagonals.

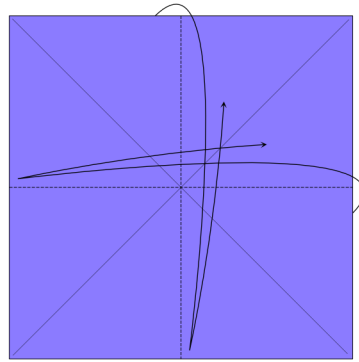

2. Crease in half vertically and horizontally.

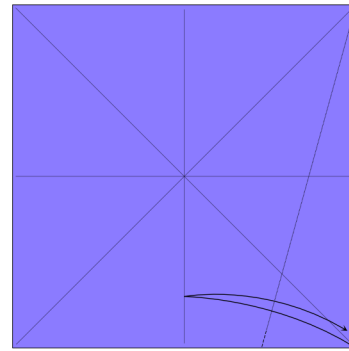

3. Fold the bottom right corner to the vertical center line, pinch where indicated. The new crease should touch the top right corner.

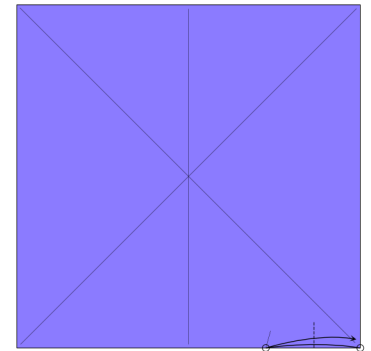

4. Fold the bottom right corner to the new mark, make a small crease and unfold.

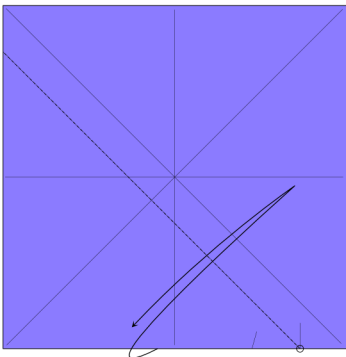

5. Starting from the new mark, make a diagonal crease along the whole sheet.

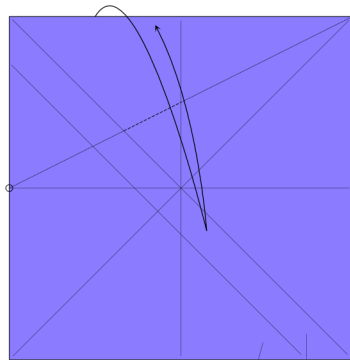

6. Make a crease starting from the middle of the left side and ending on the top right corner, creasing sharply only where indicated.

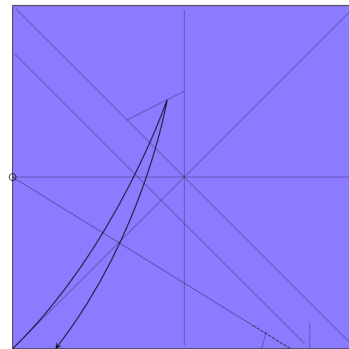

7. Fold the left edge to the newly made crease line, pinching only where indicated.

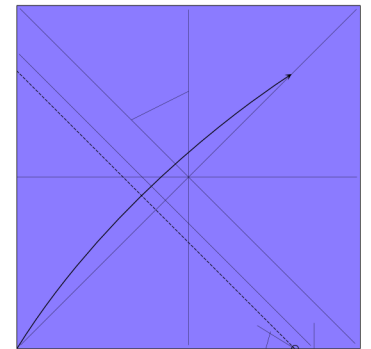

8. Fold the bottom corner diagonally, passing through the new mark.

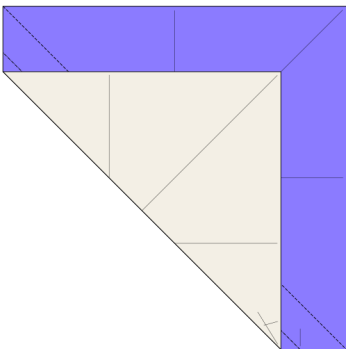

9. Pleat along existing creases.

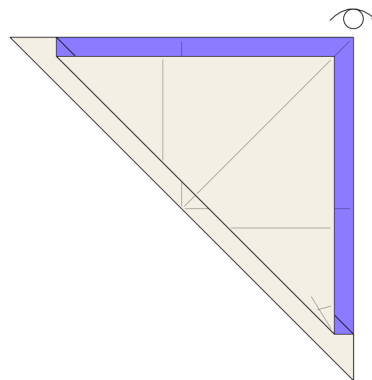

10. Turn the model over.

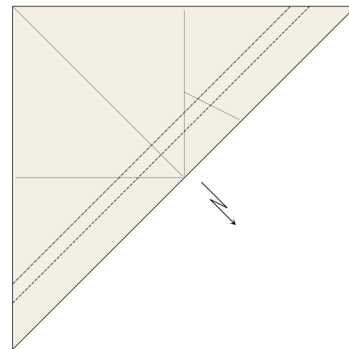

11. Pleat the upper layer so that it matches the far side.

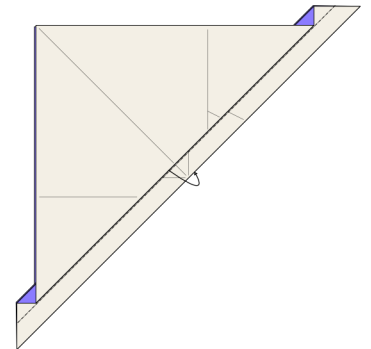

12. Fold the thin edge behind to line up with the existing edges.

- Intended for free distribution -

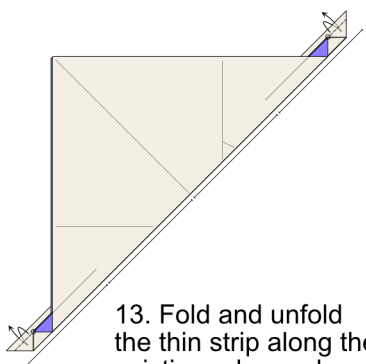

13. Fold and unfold the thin strip along the existing edge, only creasing about 1/4 from each corner.

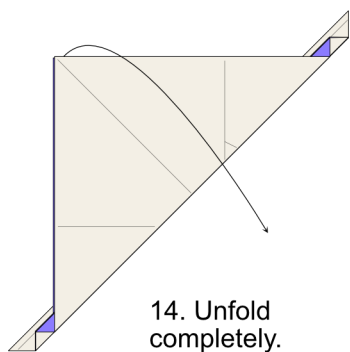

14. Unfold completely.

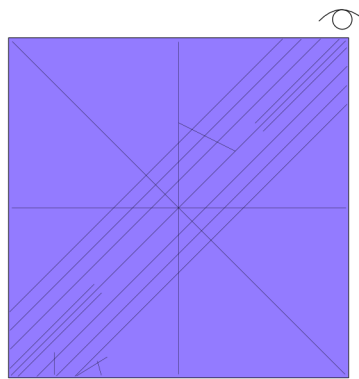

15. Turn the sheet over.

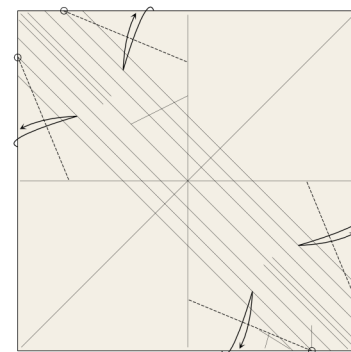

16. Crease four angle bisectors.

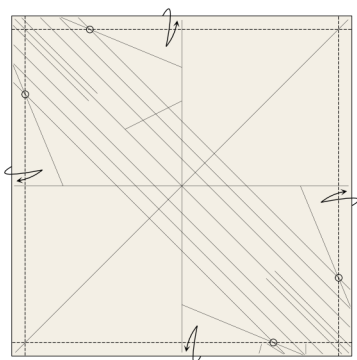

17. Fold and unfold the edge through the indicated crease intersections.

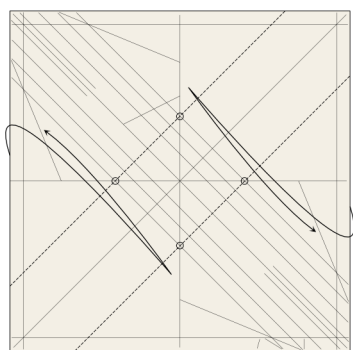

18. Crease diagonally through the indicated crease intersections.

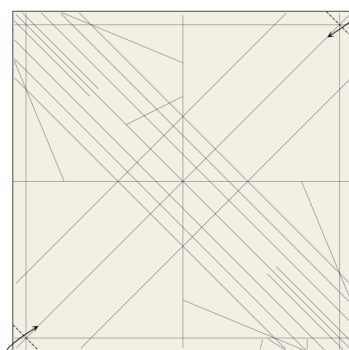

19. Fold two corners in at the intersection of creases.

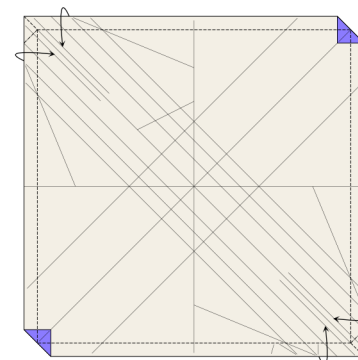

20. Make two rabbit ears.

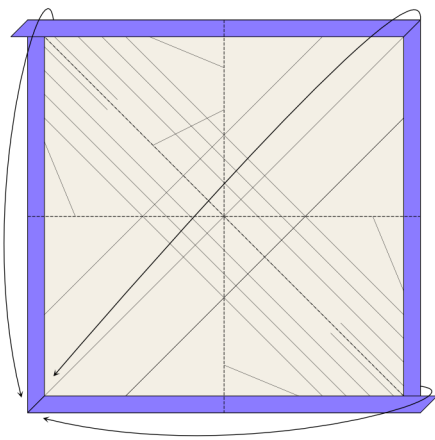

21. Preliminary fold.

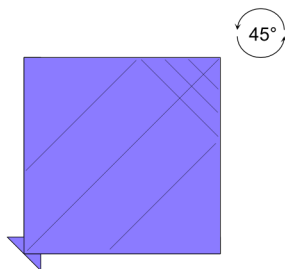

22. Rotate counter-clockwise 45°

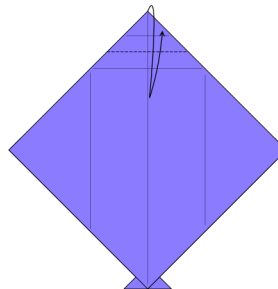

23. Crease the tip along an existing crease.

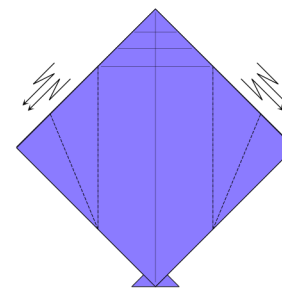

24. Crimp the flaps, repeat behind.

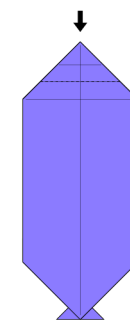

25. Open-sink the tip.

- Intended for free distribution -

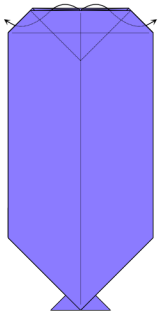

26. Reverse-fold two flaps outwards.

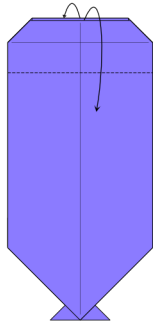

27. Valley-fold the upper flap downwards; repeat behind.

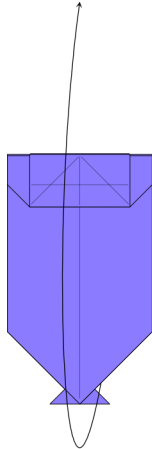

28. Open the model by lifting the bottom near flap; the model will not lie flat.

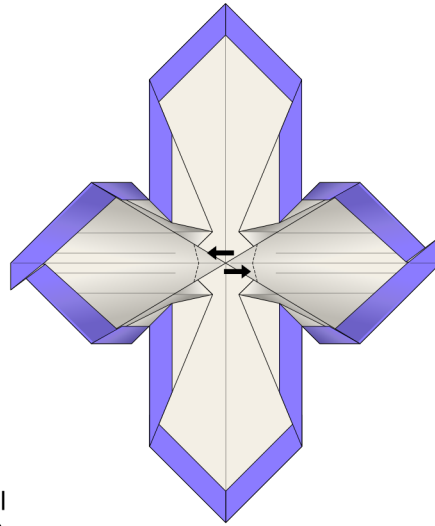

29. Press flat the base of the two side flaps near the center of the model.

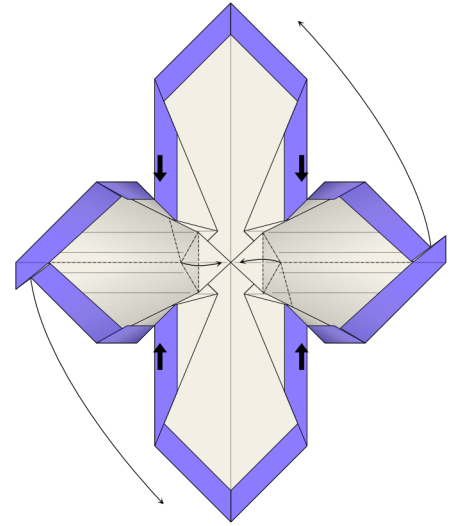

30. Pinch each flap and form a rabbit ear, flattening the right side flap upwards and the left side flap downwards.

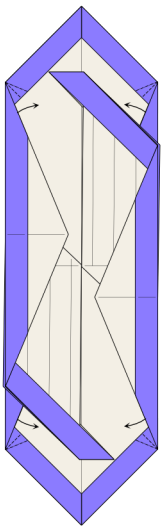

31. Untuck a small amount of paper from four corners, forming new pleats.

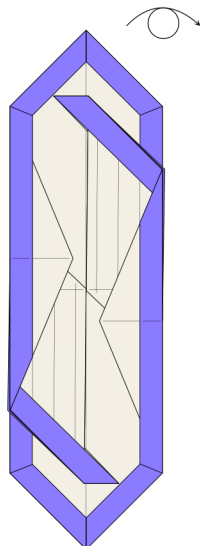

32. Flip the model over.

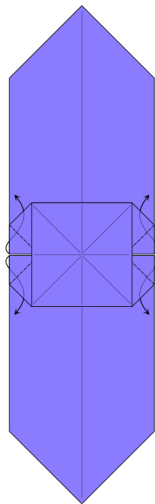

33. Reverse fold four corners.

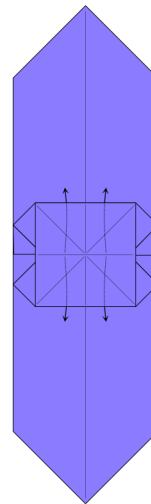

34. Unsink a layer from inside of each pocket.

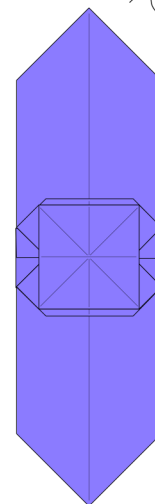

35. Flip the model over.

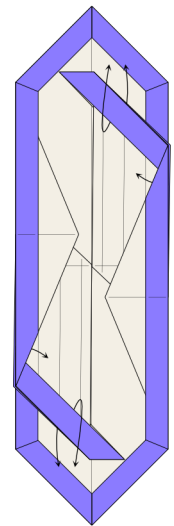

36. Unwrap the thin edge of paper from the two flaps.

- Intended for free distribution -

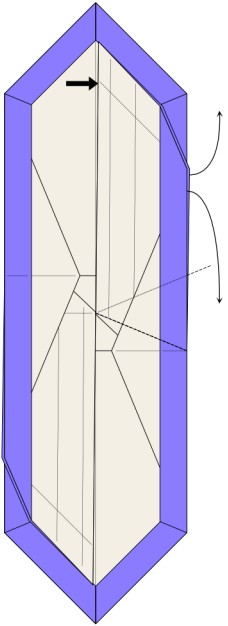

37. Open up the flap, creasing where indicated.

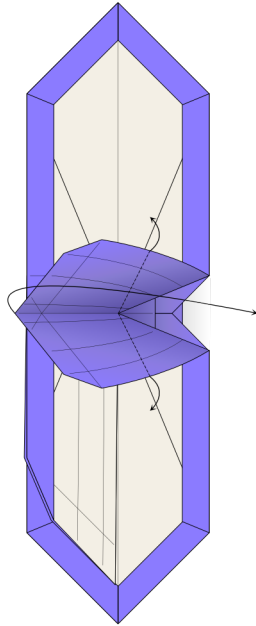

38. Squash fold.

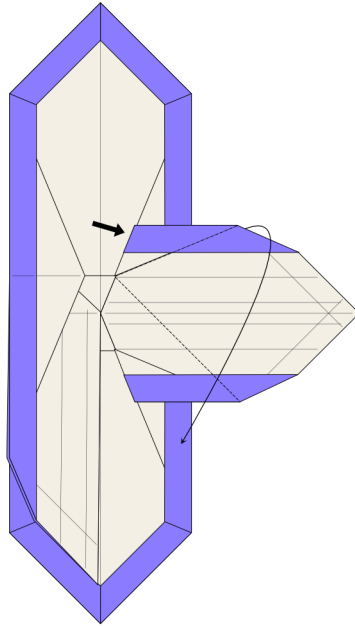

39. Swivel fold.

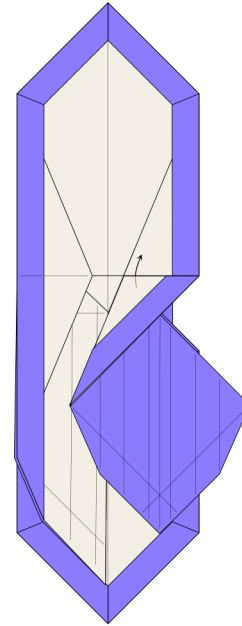

40. Untuck some paper.

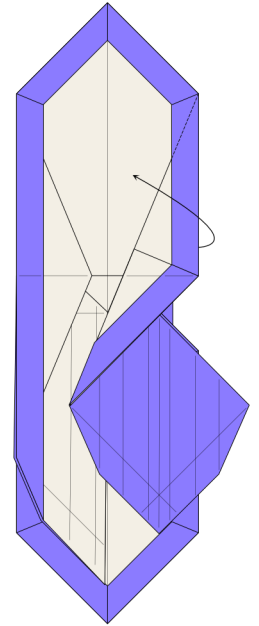

41. Start to open the flap; the model will not lie flat.

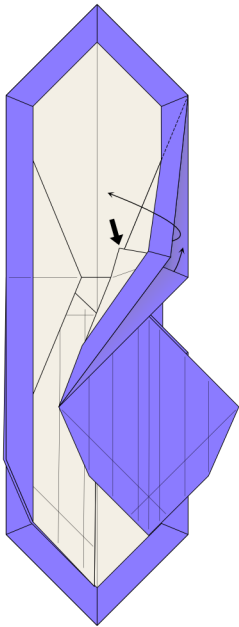

42. Unlock some layers of paper so that the flap can be flipped completely.

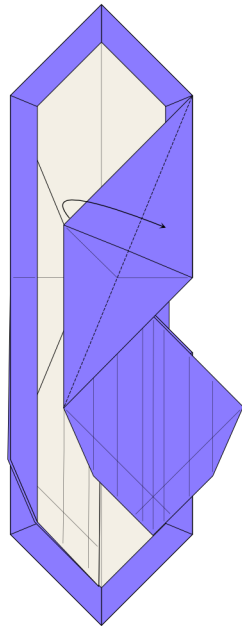

43. Close the flap again.

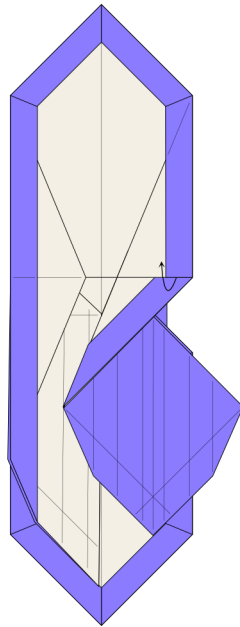

44. Untuck a small flap from the pocket.

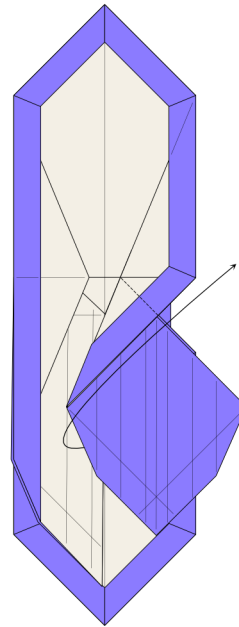

45. Valley fold.

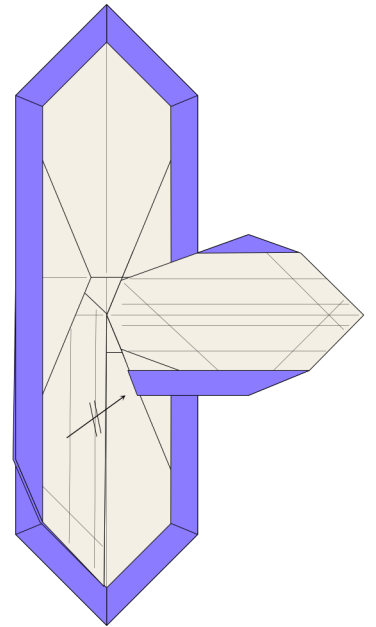

46. Repeat steps 39-45 on the other side of the flap.

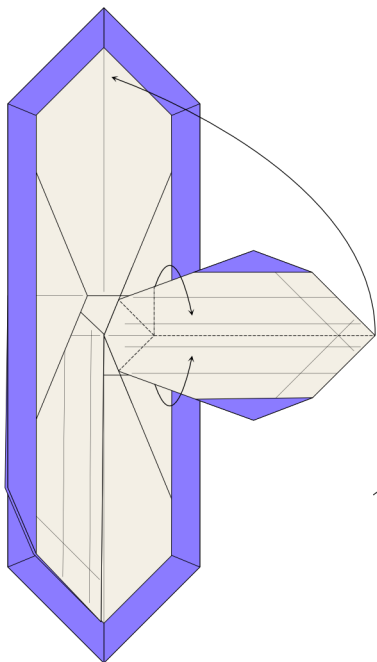

47. Rabbit-ear the flap upwards.

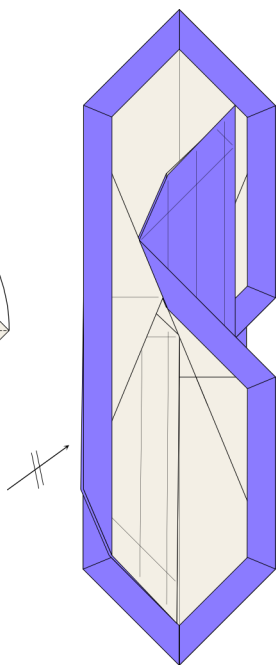

48. Repeat steps 39-47 on the left side.

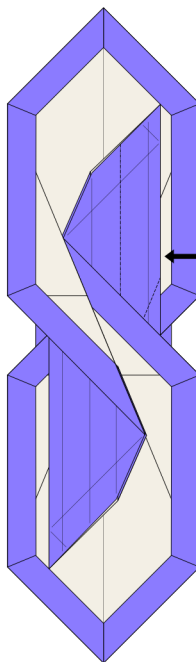

49. Open sink.

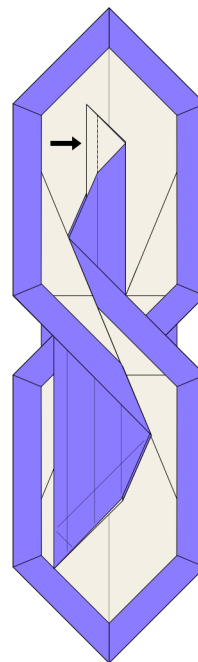

50. Open sink.

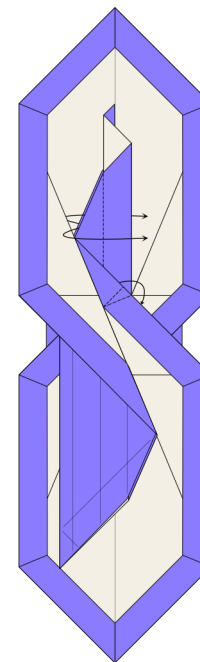

51. Swivel fold, repeat on the opposite side of the flap.

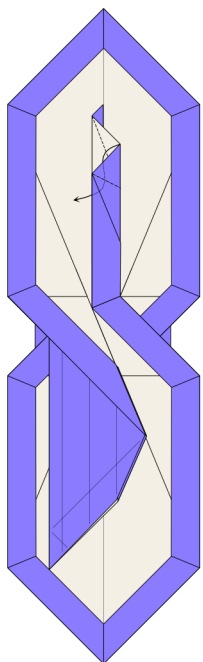

52. Reverse fold.

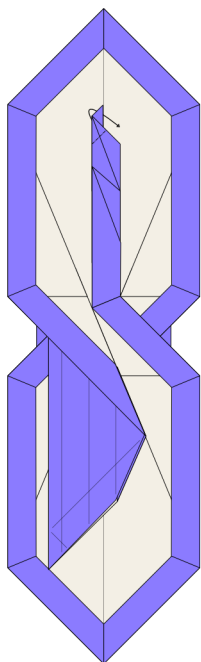

53. Mountain fold.

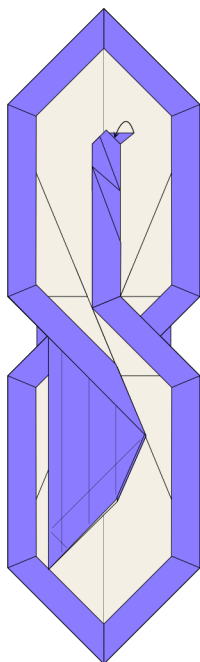

54. Valley fold, tuck the corner inside.

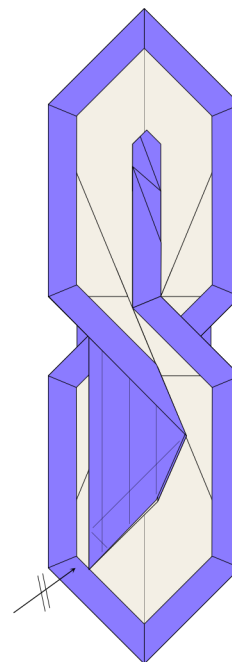

55. Repeat steps 49-54 on the left flap.

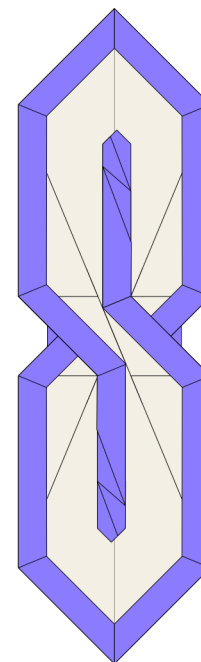

Finished Universal 'S' Symbol.