

# Torch Heart

Designed by: Yossi Nir  
Diagram by: Yossi Nir

Difficulty level: \*\*  
Paper: 15x15 kami Double-Sided  
Heart size: 11x10 cm

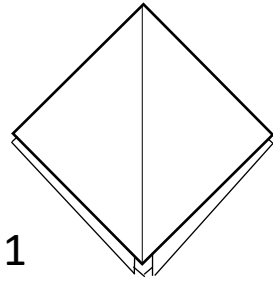

1

Start with preliminary base.  
The upper color side is the  
heart color.

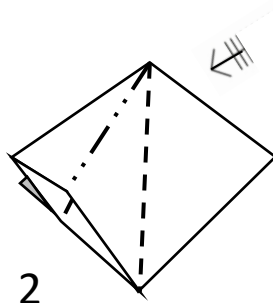

2

Lift the left upper flap and  
make a squash.  
Repeat 3 times.  
Open the paper.

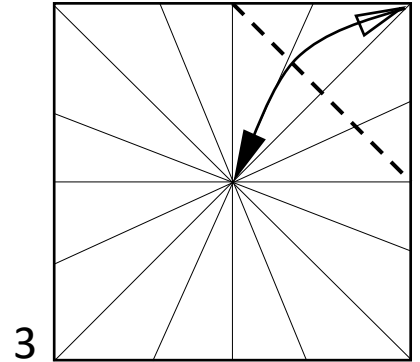

3

Valley fold  
Unfold.

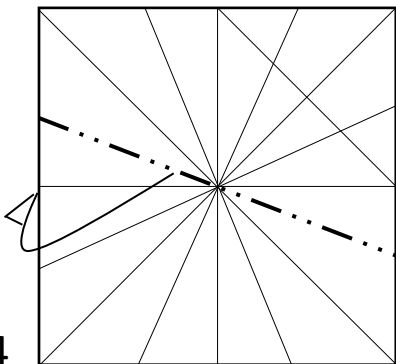

4

Mountain fold.  
Rotate 45° to the left.

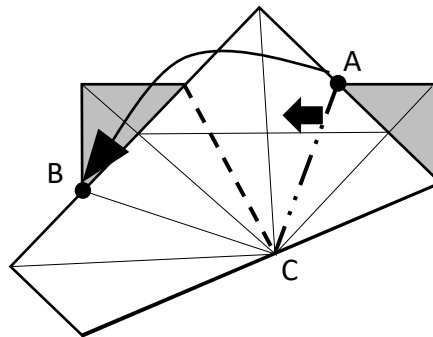

5

Valley fold the upper layer.  
Bring A to B. Line AC to be on line BC.  
Rotate 45° to the right.

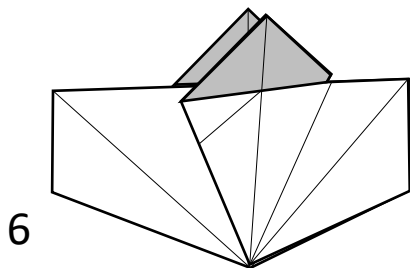

6

Turn over.

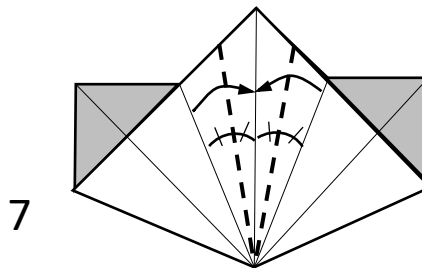

7

Valley folds all layers as bisector.

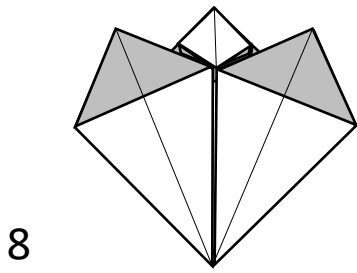

8

Unfold the last step..

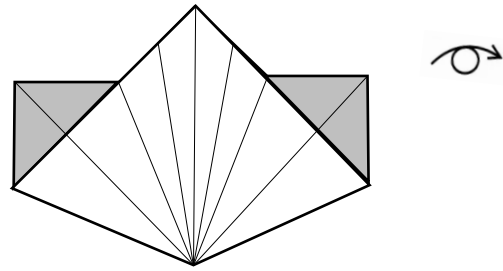

9

Turn over.

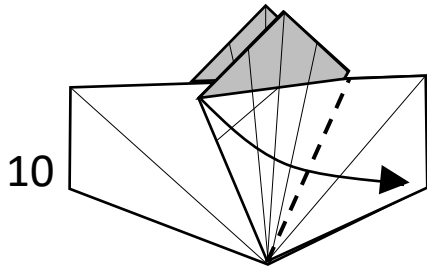

10

Valley fold.

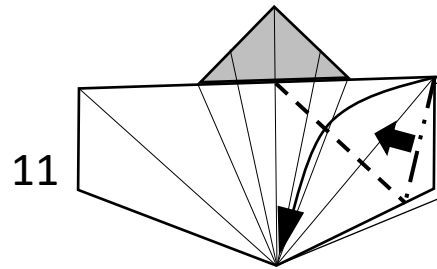

11

Swivel fold.

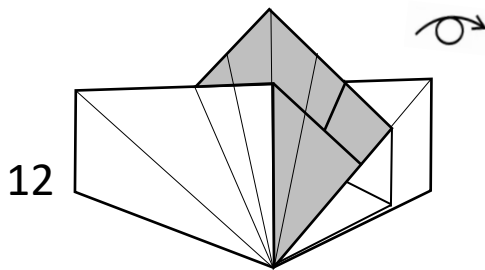

12

Turn over.

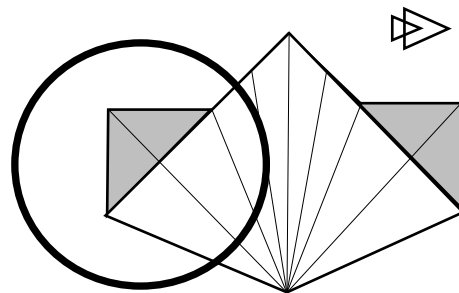

13

Zoom out.

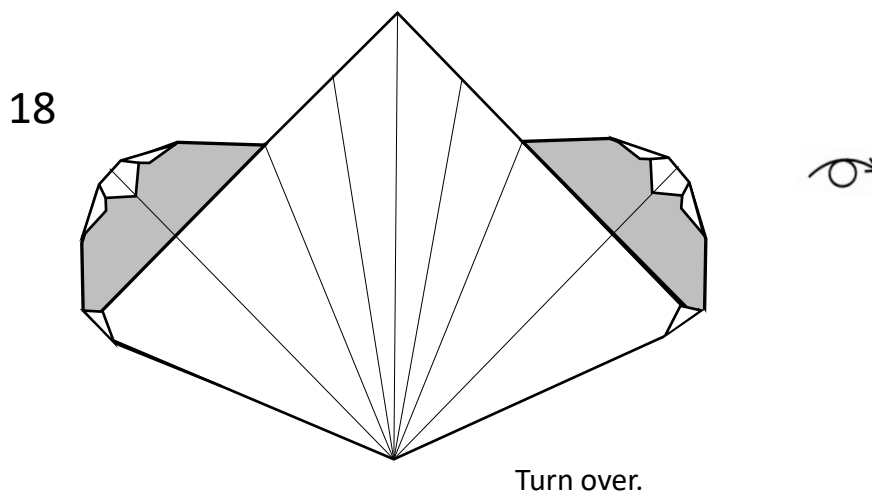
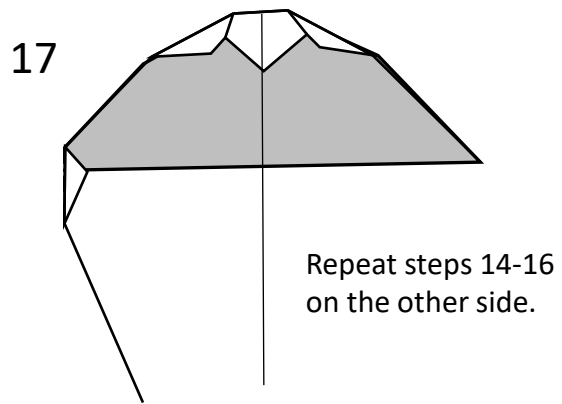
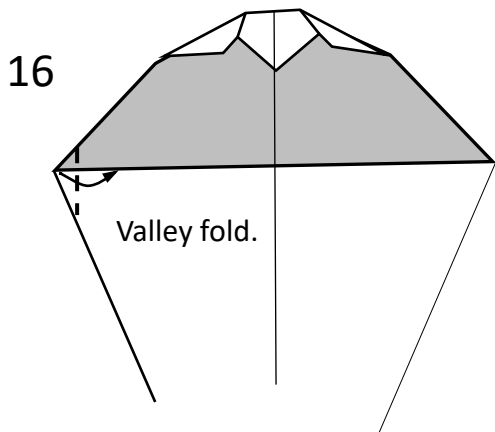
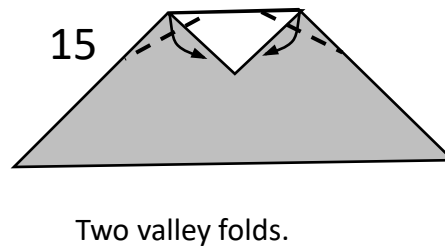
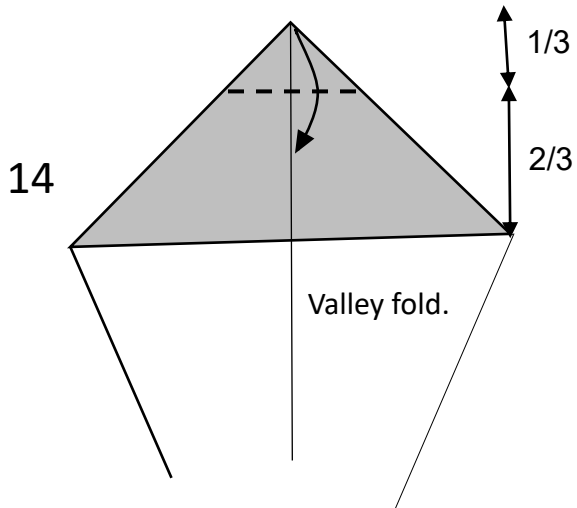

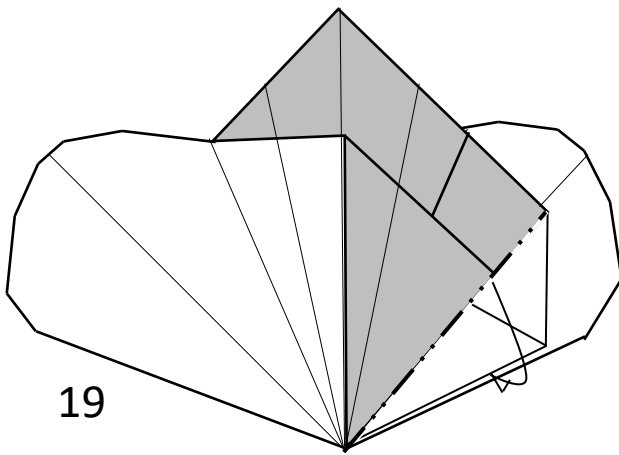

19

Mountain fold the upper layer .

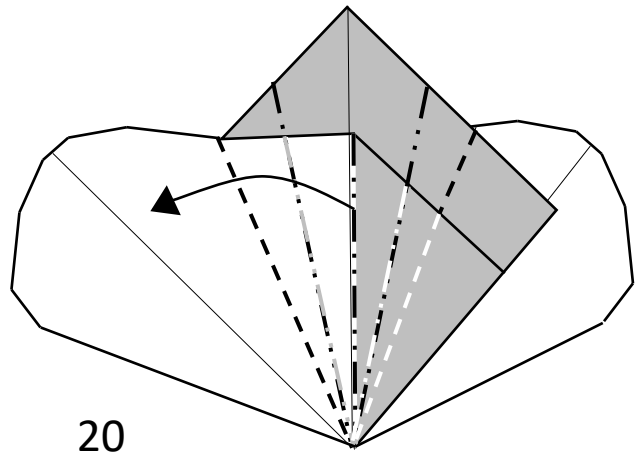

20

Valley fold.  
The two half-heart will meet behind.

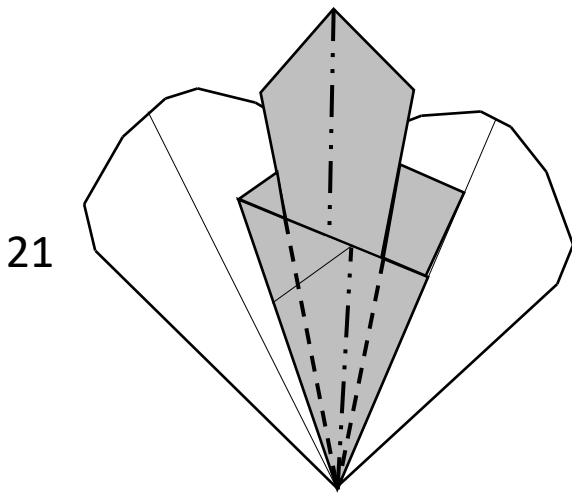

21

Pinch all layers of the torch  
to make the torch a 3D shape.

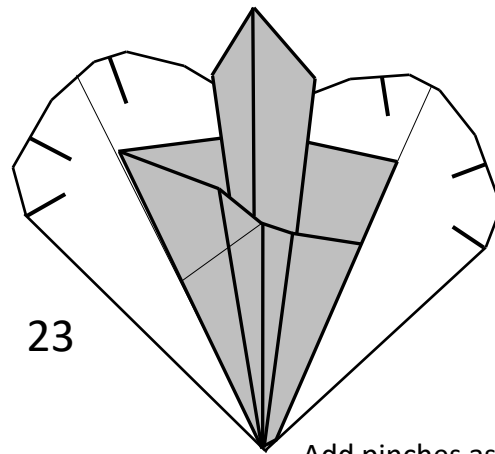

23

Add pinches as identified.

24

**TORCH HEART  
FINISHED**

