

# Semiregular STAR

Natalia Guzowska

...

Diagrammed by

**Cristele Collados**

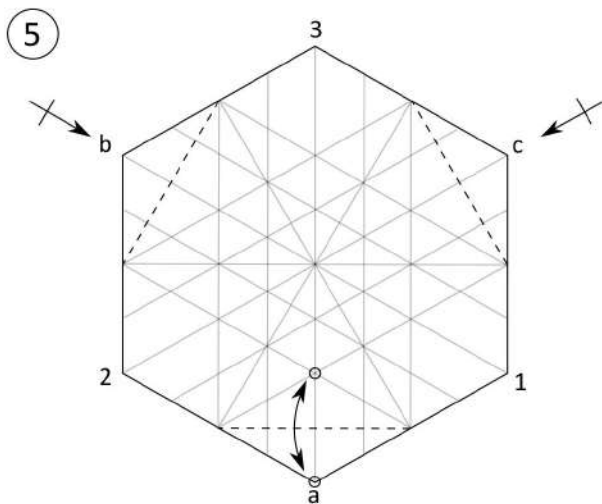
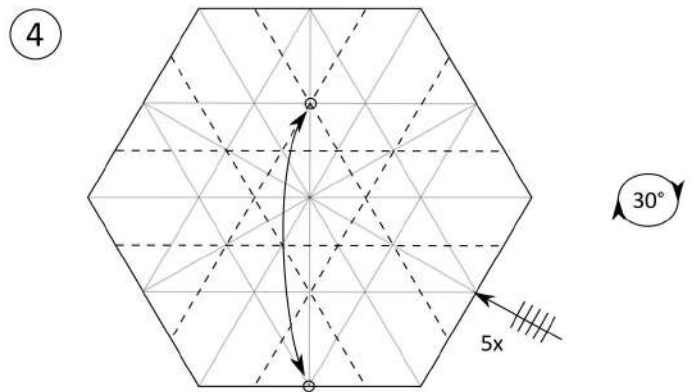
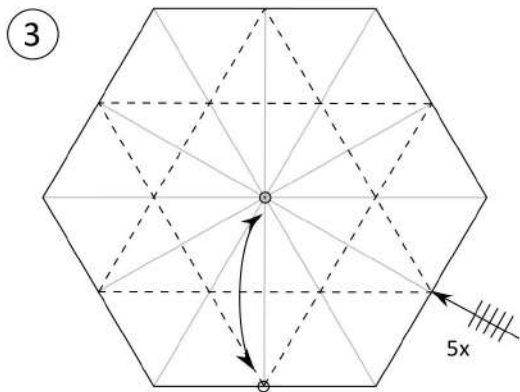
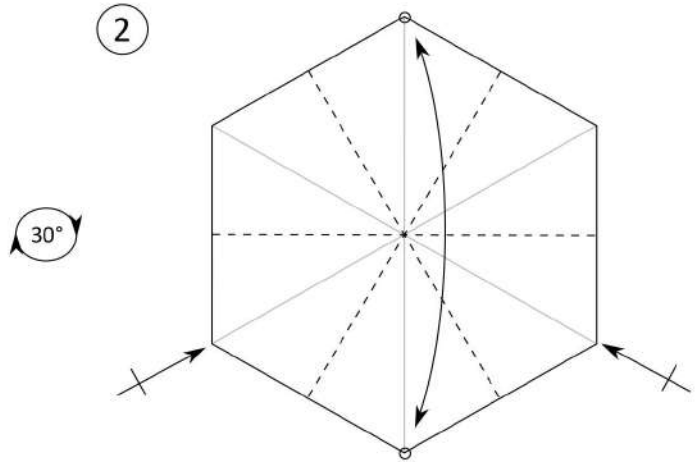
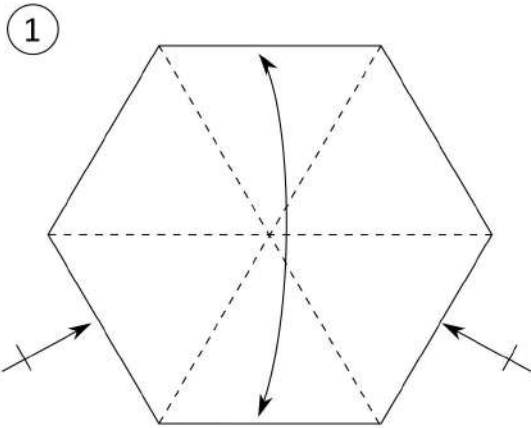
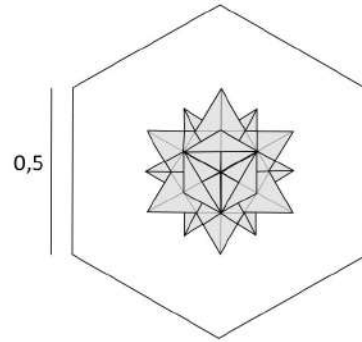

Repeat only on points b and c

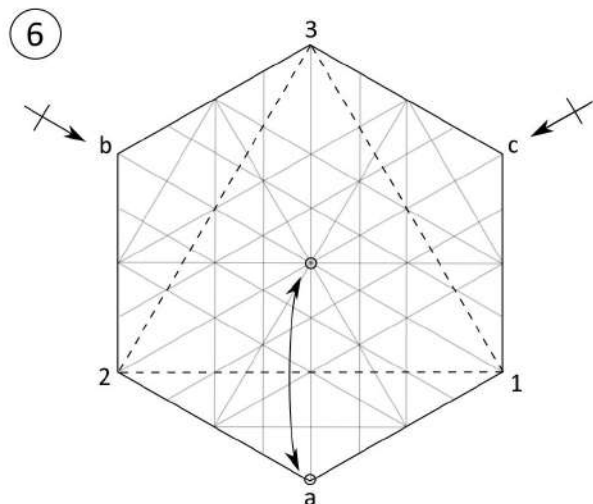

Repeat only on points b and c



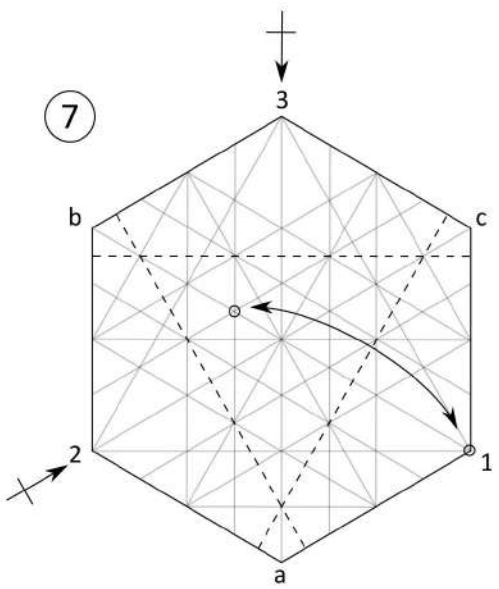

Repeat only on points 2 and 3

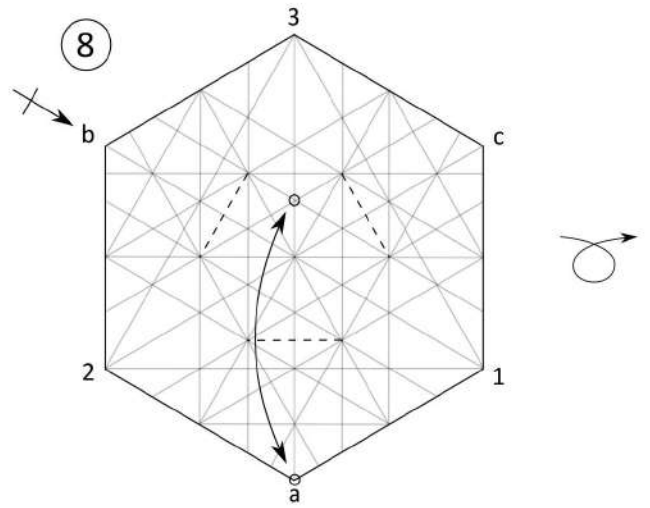

Repeat only on points b and c

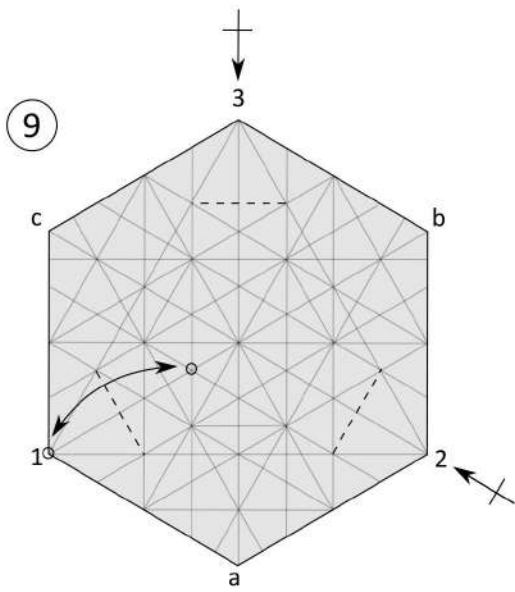

Repeat only on points 2 and 3

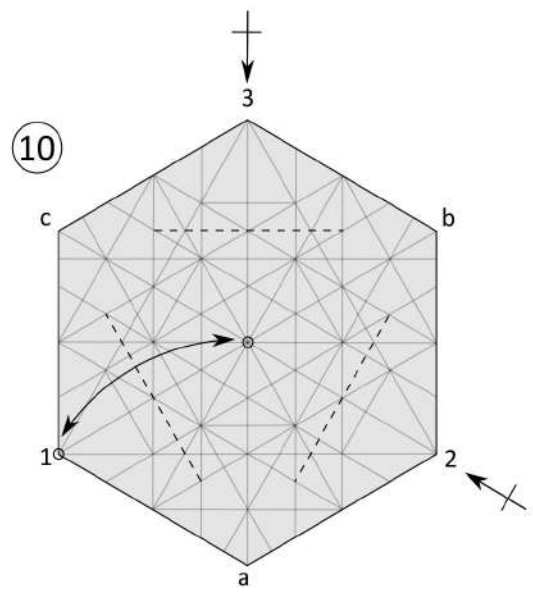

Repeat only on points 2 and 3

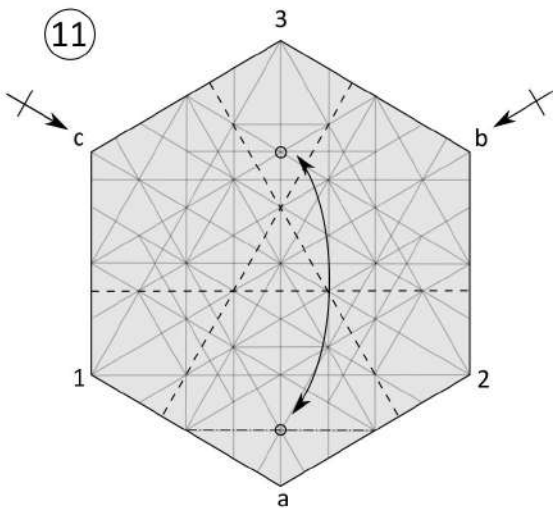

Repeat only on points b and c

*The easiest way is to fold the crease made on step 5 and align the edge with the crease made on step 10*

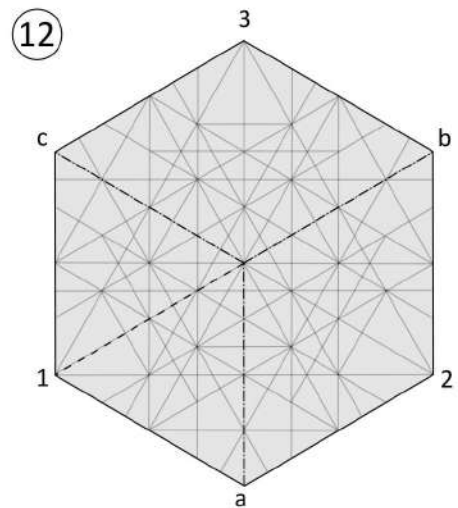

Bring points 1, 2 and 3 together

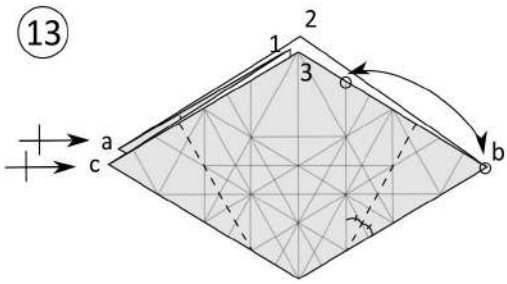

Repeat on points a and c  
Unfold

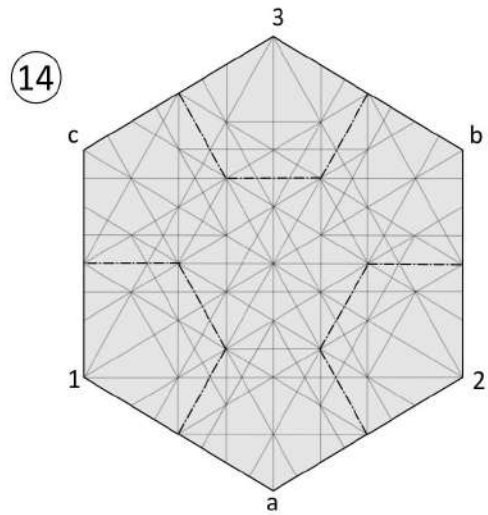

Collapse - Step 1  
Mark the indicated creases

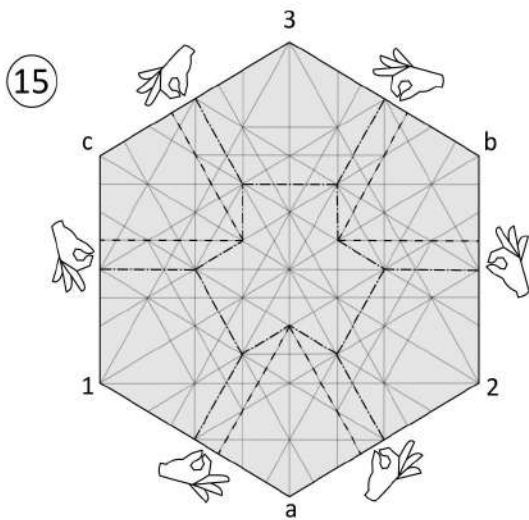

Collapse - Step 2  
Pinch to mark the additional creases

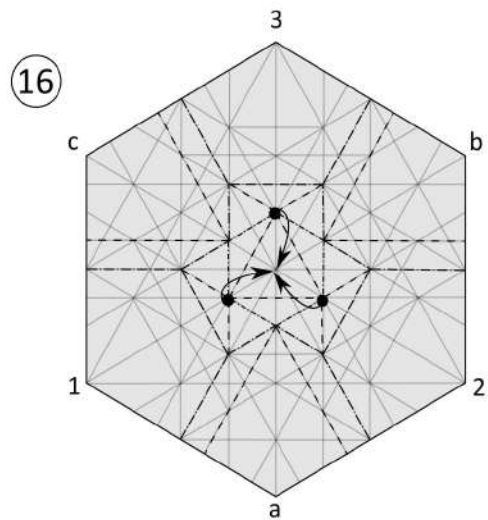

Collapse - Final step  
Push down the central triangle,  
bringing the circle points towards the center

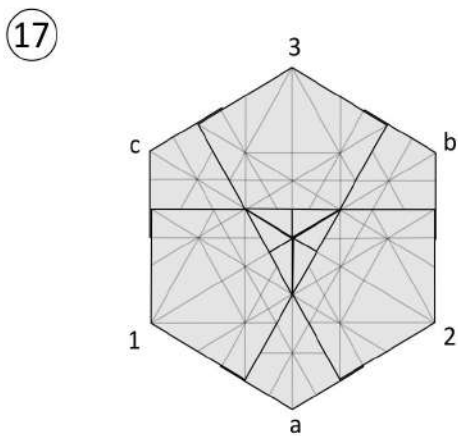

Front view

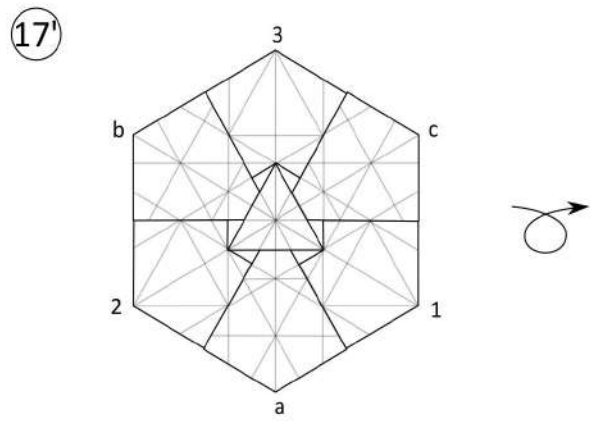

Back view



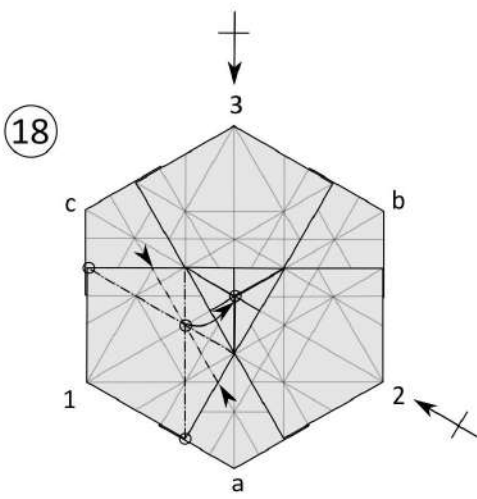

18

Slightly pull point 1  
 Push where indicated and bring the newly created tip  
 down to the center (see result next step)  
 Repeat on points 2 and 3

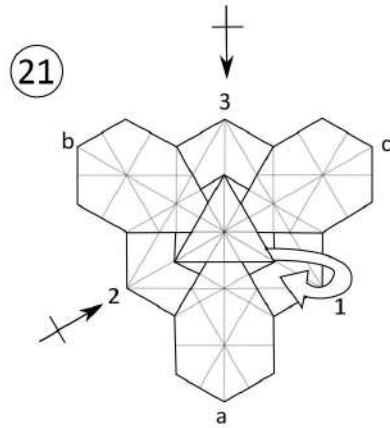
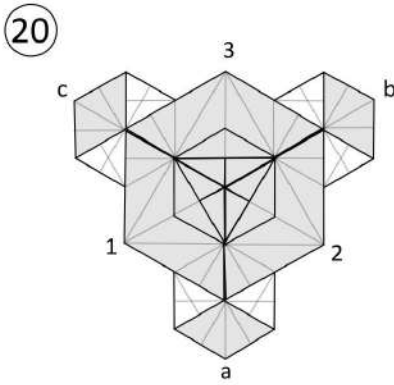
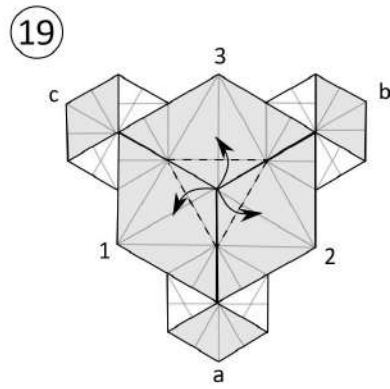

21

Hide the point of the central triangle  
 in the pocket behind (see next step).  
 Repeat on points 2 and 3

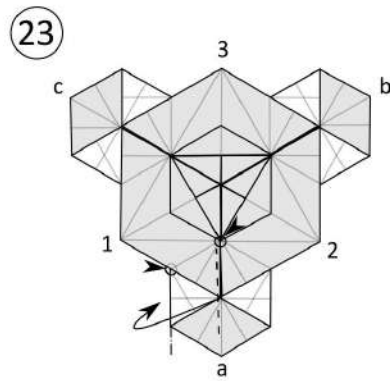
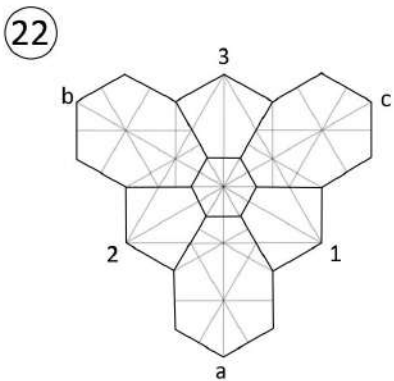

23

Reverse the white flap, pushing  
 the circled corners outside-in.  
 The model will not lie flat

24

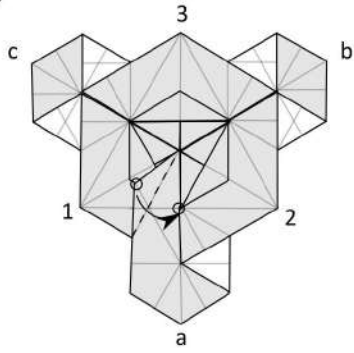

Flatten the model

25

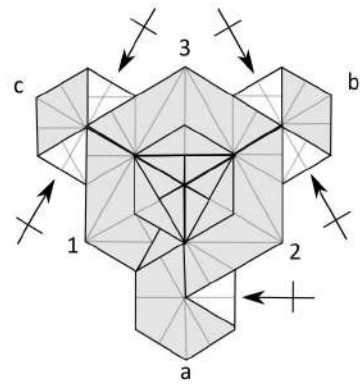

Repeat steps 23 and 24 on the other 5 white flaps

26

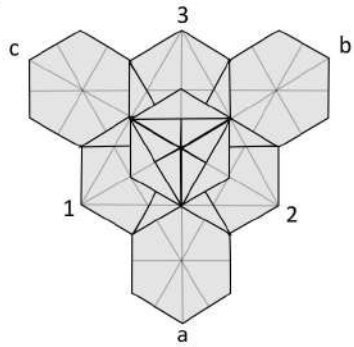

26'

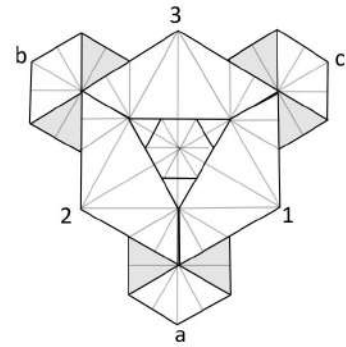

Back view

27

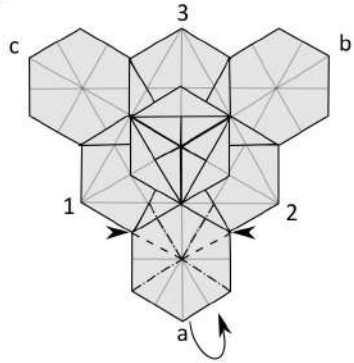

Sink  
Flatten the tip backwards

28

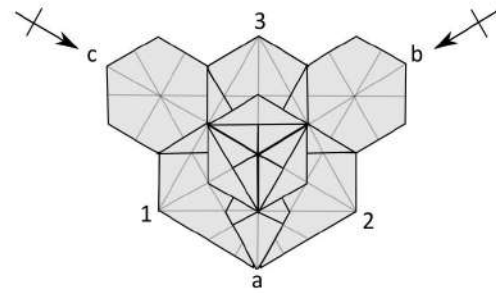

Repeat on points b and c

29

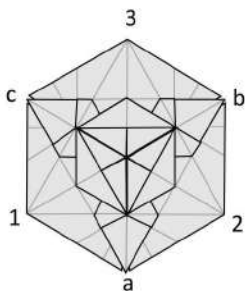

30

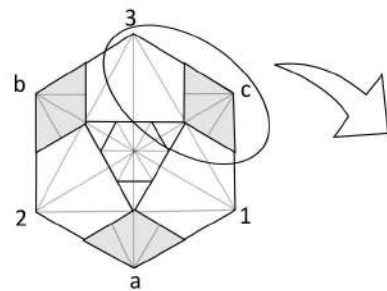

31

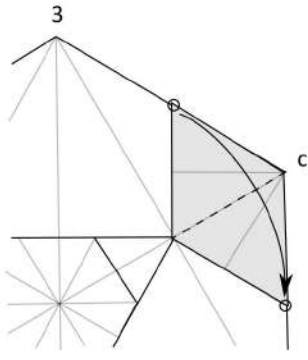

32

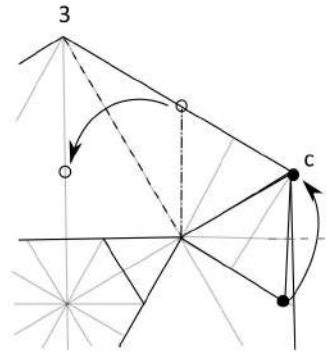

Swivel all layers

33

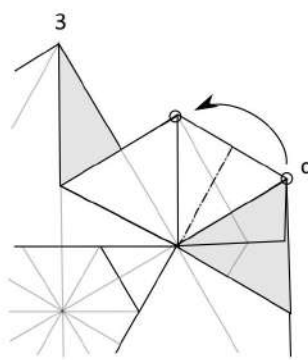

Swivel

34

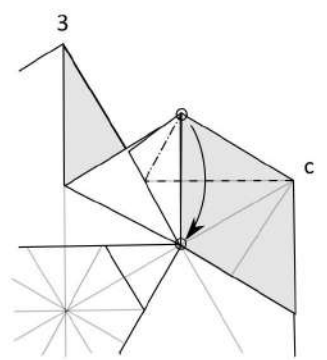

Fold down and squash

35

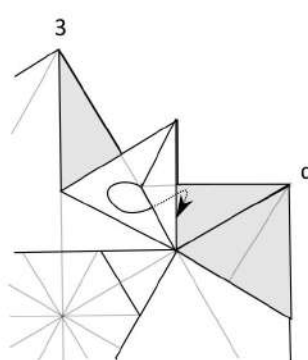

Tuck the tip inside the pocket

36

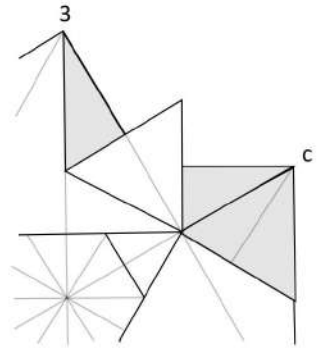

Repeat steps 31 to 35 on the 5 other flaps

37

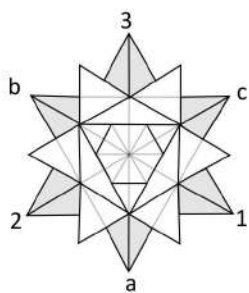

Back view



37'

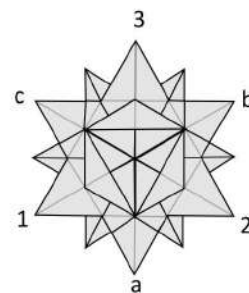

Finished!

